



NODOR
always innovating

GENERAL CATALOGUE 2022



The technical characteristics indicated in the catalogue must be verified by the **THE MANUFACTURER**.

Non-contractual photographs.

Cata Electrodomésticos S.L. reserves the right to modify the characteristics of its products without prior notice.

© Design, layout, images and content are the property of

Cata Electrodomésticos S.L.

GENERAL CATALOGUE 2022



Forget the boring stainless steel, welcome the purity of the colour.
New solutions for the design of kitchen environments with the Nodor range.



The stylish environments are constantly renewed and to respond to this constant evolution, the exclusive ranges of Nodor **SNOW-WHITE** and Nodor **DARKBLACK** are born.



Black is back. Its minimalist and elegant design matches with all types of environments, providing a sophisticated look to each kitchen with its chrome details and its finishes in pure black glass.



Black or White. The new Nodor appliances have a captivating aesthetic without neglecting our responsibility commitment to the environment, which starts during the production process and is translated into low-energy consumption classifications. With the advantage of being able to choose between pure white crystal or pure black crystal.



The Nodor appliances are different, we like the details, we appreciate the design and technology because it is in our DNA. That's why the **COPPER** range is born, unique appliances, designed to satisfy the most demanding chefs for their technology and ease of use. It was never so easy to cook as it is with the new Copper Nodor range.



For those looking for something different, for those who do not follow the rules, for those with a non-conformist nature, for those who want to be different, the new Nodor **COLOURDOT** range is born, providing a modern and lively touch to your kitchen.



For those looking for an unmistakable design inspired by the 50 or a personal touch to their home without forgetting the technological advantages that Nodor has been providing since 1977, the new Nodor **RETROLINE** range is born.

MULTIFUNCTION OVEN

NorChef MO 6800 DB

Cod.: 2114/ EAN: 8435025721142



- » 67 litres* Nsoft multifunction oven
- » Black glass door and control panel with chromed handle
- » White LCD display with start/stop digital programmer
- » Nsoft multifunction with 10 functions
- » Nhome-baked function
- » Nclean Easy-To-Clean enamel
- » Ncomfort telescopic guides with full extraction
- » A** Energy efficiency class

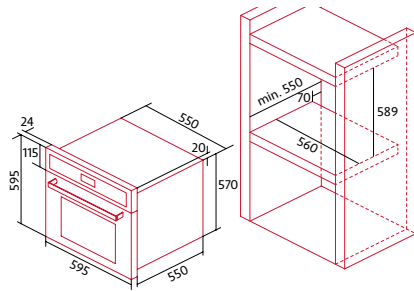

MULTIFUNCTION STEAM OVEN

NorChef MO 4800 DB

Cod.: 2115/ EAN: 8435025721159



- » 40 litres* Nsoft multifunction oven
- » Black glass door and control panel with chromed handle
- » White LCD display with start/stop digital programmer
- » Nsoft multifunction with 8 functions
- » Nhome-baked function
- » Nclean Easy-To-Clean enamel
- » Telescopic guides with full extraction
- » A** Energy efficiency class

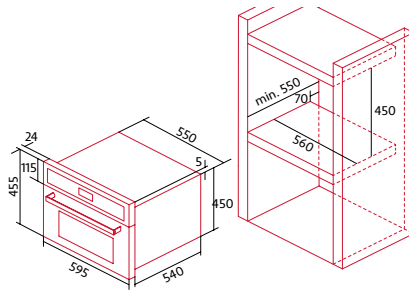

MULTIFUNCTION OVEN

NorChef SO 4800 DB

Cod.: 2116/ EAN: 8435025721166



- » 36 litres* Nsoft multifunction steam oven
- » Black glass door and control panel with chromed handle
- » White LCD display with start/stop digital programmer
- » Nsoft multifunction with 8 functions
- » Nsteam function
- » Decaling function
- » Nsteelclean Easy-To-Clean
- » 1.2L water tank
- » A+** Energy efficiency class

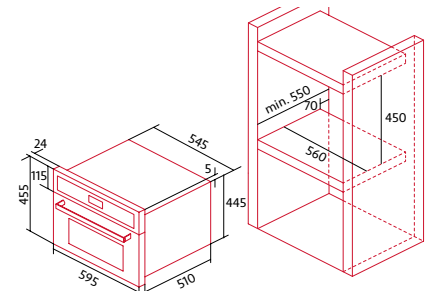

MULTIFUNCTION COMBI MICROWAVE

NorChef MW 4800 DB

Cod.: 2117/ EAN: 8435025721173



- » 40 litres* Nsoft multifunction microwaves oven
- » Black glass door and control panel with chromed handle
- » White LCD display with start/stop digital programmer
- » Nsoft multifunction with 8 functions
- » 8 Programs
- » Nsteelclean Easy-To-Clean

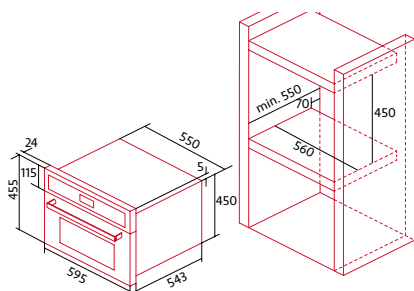

WINE COOLERS

Norcare VC 4800 DB

Cod.: 4184/ EAN: 8435025741843



- » Built-in and column installation no frost wine cooler
- » No Frost technology
- » Electronic temperature regulation between 5-20°C
- » Fold-away door with soft close/open hinge
- » Wood shelves
- » Inner led
- » Four levels of storage
- » Efficiency energy class F***
- » Accessory: Copper handle. (7090060) Page.27

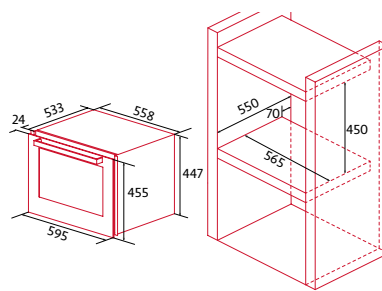

WARMING DRAWER

NorChef WP 1500 DB

Cod.: 2122/ EAN: 8435025721227



- » 20 liters warming drawer
- » Black glass door with Npush opening with telescopic opening
- » Non-slip base
- » Slow cooking temperature selector. From 30° to 75°C
- » Leavening temperature selector. 30°C
- » Heating dishes temperature selector. 75°C
- » Keep warm temperature selector. From 40° to 60°C
- » 75°C max. Temperature
- » 12 dishes or 64 espresso cups capacity

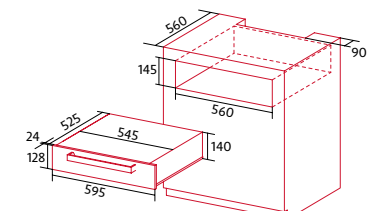

MICROWAVE

NorChef MW 25 DG DB

Cod.: 4053/ EAN: 8435025740532



- » 25 litres, 900 W and with 1000 W grill built-in microwave
- » Stainless steel cavity and touch door opening
- » Defrosting, heating and cooking by time and type of meal
- » 5 levels of power cooking selection
- » 4 levels of power grill selection
- » 95 min. time selector with display
- » Diameter of glass dish 315 mm
- » Maximum diameter for a dish 320 mm
- » Microwave frame integrated

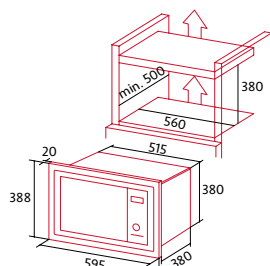

HOOD

NorBreeze UNUM 90 DB NMOTION

Cod.: 8512/ EAN: 8435025785120



- » Angle Glass wall hood
- » 5 extraction levels and booster
- » 135 W Brushless motor, BT4DC
- » Max / Min extraction rate: 843,6 / 265,2 m3/h
- » Lighting LED bar and ambient light
- » Non condensation filter
- » Decorative stainless steel filters washable in dishwasher
- » Optional carbon filter accessory
- » Efficiency energy class A+**

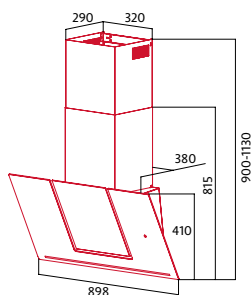

HOOD

NorBreeze CUADRATUM 90 DB NMOTION

Cod.: 8515/ EAN: 8435025785151



- » Angle Glass wall hood
- » Perimeter extraction
- » 5 extraction levels and booster
- » 135 W motor, BT4DC
- » Max / Min extraction rate: 841,6 / 282,8 m3/h
- » Lighting LED bar and ambient light
- » Non condensation filter
- » Standard metallic filters washable in dishwasher
- » Optional carbon filter accessory
- » Efficiency energy class A+**

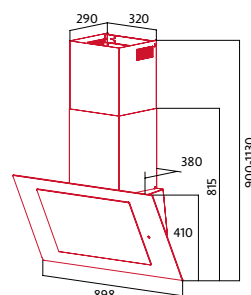

HOOD

NorBreeze CIRCUM 90 DB NMOTION

Cod.: 8513/ EAN: 8435025785137



- » Angle Glass wall hood
- » Perimeter extraction
- » 5 extraction levels and booster
- » 135 W motor, BT4DC
- » Max / Min extraction rate: 851,6 / 270,8 m3/h
- » Lighting LED bar and ambient light
- » Non condensation filter
- » Standard metallic filters washable in dishwasher
- » Optional carbon filter accessory
- » Efficiency energy class A+**

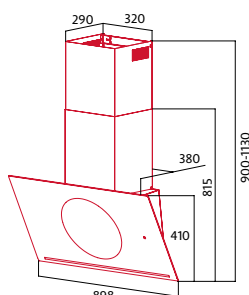

HOOD

NorBreeze MISTRAL 90 DB

Cod.: 8516/ EAN: 8435025785168



- » Angle Glass wall hood
- » 5 extraction levels and booster
- » 135 W motor, BT4DC
- » Max / Min extraction rate: 841,6 / 282,8 m3/h*
- » Lighting LED bar
- » Standard metallic filters washable in dishwasher
- » Optional carbon filter accessory
- » Efficiency energy class A+++**

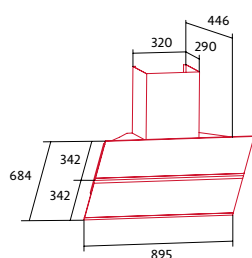

REFRIGERATORS

NorFrost HAIL 201 NF GDB

Cod.: 8590/ EAN: 8422248104982



- » Ndualzone No Frost 2,02m combi with black safety glass door fridge
- » Electronic temperature regulation
- » Nfreshzone system that distributes the cold in an efficient and stable way
- » Metallic interior finishes and aluminium panel
- » Nchilly function in refrigerator and Nsubzero in freezer
- » Nsave function
- » Refrigerator: 1 Nlifebox drawer and 1 Ngreenbox drawer
- » Net capacity: 378L
- » Efficiency energy class E***
- » Reversible doors

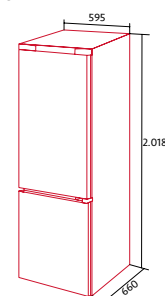

* net capacity / ** within the range A+++ to D / *** within the range A to G

MULTIFUNCTION OVEN

NorChef MO 6800 SW

Cod.: 2118 / EAN: 8435025721180



- » 67 litres* Nsoft multifunction oven
- » White glass door and control panel with chromed handle
- » White LCD display with start/stop digital programmer
- » Nsoft multifunction with 10 functions
- » Nhome-baked function
- » Nclean Easy-To-Clean enamel
- » Ncomfort telescopic guides
- » A** Energy efficiency class

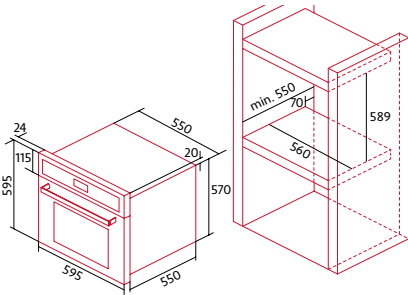

MULTIFUNCTION OVEN

NorChef MO 4800 SW

Cod.: 2119 / EAN: 8435025721197



- » 40 litres* Nsoft multifunction oven
- » White glass door and control panel with chromed handle
- » White LCD display with start/stop digital programmer
- » Nsoft multifunction with 8 functions
- » Nhome-baked function
- » Nclean Easy-To-Clean enamel
- » Telescopic guides with full extraction
- » A** Energy efficiency class

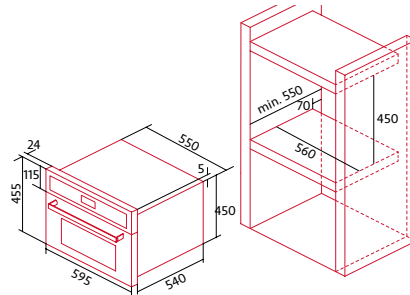

MULTIFUNCTION STEAM OVEN

NorChef SO 4800 SW

Cod.: 2120 / EAN: 8435025721203



- » 36 litres Nsoft multifunction steam oven
- » White glass door and control panel with chromed handle
- » White LCD display with start/stop digital programmer
- » Nsoft multifunction with 8 functions
- » Nsteam function
- » Decaling function
- » Nsteelclean Easy-To-Clean
- » 1.2L water tank
- » A** Energy efficiency class

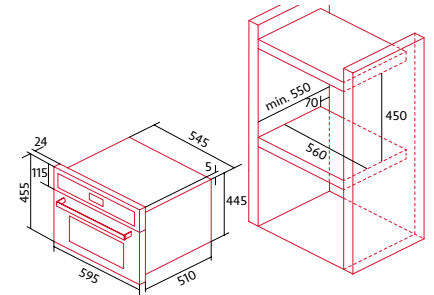

MULTIFUNCTION COMBI MICROWAVE

NorChef MW 4800 SW

Cod.: 2121 / EAN: 8435025721210



- » 40 litres* Nsoft multifunction microwaves oven
- » White glass door and control panel with chromed handle
- » White LCD display with start/stop digital programmer
- » Nsoft multifunction with 8 functions
- » 8 Programs
- » Nsteelclean Easy-To-Clean

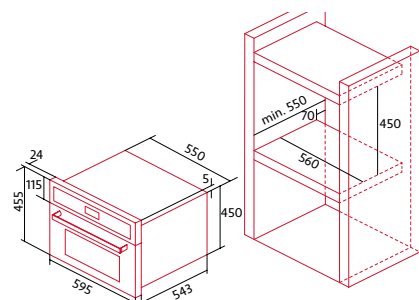

WARMING DRAWER

NorChef WP 1500 SW

Cod.: 2123 / EAN: 8435025721234

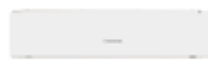

- » 20 liters warming drawer
- » Black glass door with Npush opening with telescopic opening
- » Non-slip base
- » Slow cooking temperature selector. From 30° to 75°C
- » Leavening temperature selector. 30°C
- » Heating dishes temperature selector. 75°C
- » Keep warm temperature selector. From 40° to 60°C
- » 75°C max. Temperature
- » 12 dishes or 64 expresso cups capacity

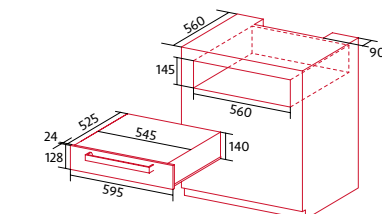

HOOD

NorBreeze MISTRAL 90 SW

Cod.: 8519 / EAN: 8435025785199



- » Angle Glass wall hood
- » 5 extraction levels and booster
- » 135 W motor, BT4DC
- » Max / Min extraction rate: 841,6 / 282,8 m3/h
- » Lighting LED bar
- » Standard metallic filters washable in dishwasher
- » Optional carbon filter accessory
- » Efficiency energy class A+++**

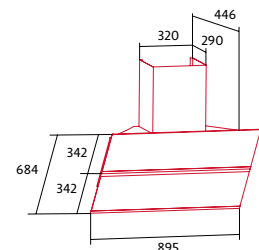

* net capacity / ** within the range A+++ to D / *** within the range A to C



REFRIGERATORS

NorFrost HAIL 201 NF GSW

Cod.: 8591 / EAN: 8422248104999



- » Ndualzone No Frost 2,02m combi with white safety glass door fridge
- » Electronic temperature regulation
- » Nfreshzone system that distributes the cold in an efficient and stable way
- » Metallic interior finishes and aluminium panel
- » Nchilly function in refrigerator and Nsubzero in freezer
- » Nsave function
- » Refrigerator: 1 Nlifebox drawer and 1 Ngreenbox drawer
- » Net capacity: 378L
- » Efficiency energy class E***
- » Reversible doors

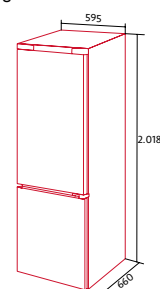

MULTIFUNCTION OVEN

NorChef MO 6800 CU

Cod.: 2124 / EAN: 8435025721241



- » 67 litres* Nsoft multifunction oven
- » Black glass door and control panel with copper handle
- » White LCD display with start/stop digital programmer
- » Nsoft multifunction with 10 functions
- » Nhome-baked function
- » Nclean Easy-To-Clean enamel
- » Ncomfort telescopic guides
- » A** Energy efficiency class

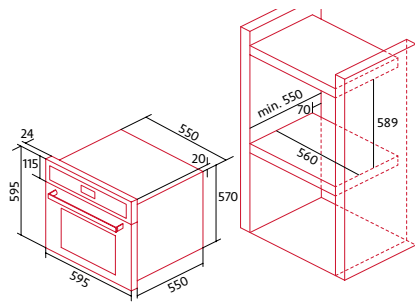

MULTIFUNCTION OVEN

NorChef MO 4800 CU

Cod.: 2127 / EAN: 8435025721272



- » 40 litres* Nsoft multifunction oven
- » Black glass door and control panel with copper handle
- » White LCD display with start/stop digital programmer
- » Nsoft multifunction with 8 functions
- » Nhome-baked function
- » Nclean Easy-To-Clean enamel
- » Telescopic guides with full extraction
- » A** Energy efficiency class

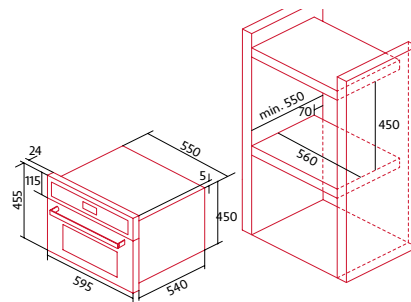

MULTIFUNCTION STEAM OVEN

NorChef SO 4800 CU

Cod.: 2125 / EAN: 8435025721258



- » 36 litres* Nsoft multifunction steam oven
- » Black glass door and control panel with copper handle
- » White LCD display with start/stop digital programmer
- » Nsoft multifunction with 8 functions
- » Nsteam function
- » Decaling function
- » Nsteelclean Easy-To-Clean
- » 1.2L water tank
- » A+** Energy efficiency class

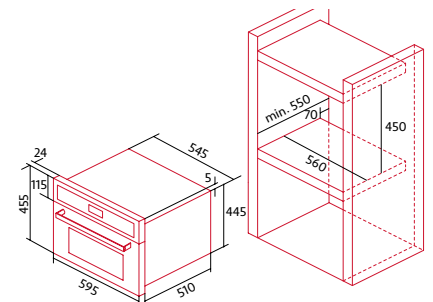

MULTIFUNCTION COMBI MICROWAVE

NorChef MW 4800 CU

Cod.: 2126 / EAN: 8435025721265



- » 40 litres* Nsoft multifunction microwaves oven
- » Black glass door and control panel with copper handle
- » White LCD display with start/stop digital programmer
- » Nsoft multifunction with 8 functions
- » 8 Programs
- » Nsteelclean Easy-To-Clean

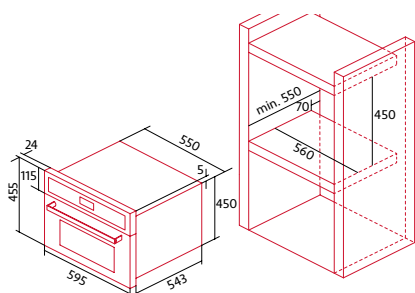

MICROWAVE

NorChef MW 25 DG CU

Cod.: 4057 / EAN: 8435025740570



- » 25 litres, 900 W and with 1000 W grill built-in microwave
- » Stainless steel cavity and touch door opening
- » Defrosting, heating and cooking by time and type of meal
- » 5 levels of power cooking selection
- » 4 levels of power grill selection
- » 95 min. time selector with display
- » Diameter of glass dish 315 mm
- » Maximum diameter for a dish 320 mm
- » Microwave frame integrated

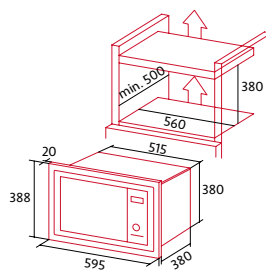

ACCESSORY

Copper Handle Accessory

Cod.: 07090060 / EAN: 8422248102681



* net capacity / ** within the range A+++ to D

HOOD

NorBreeze SLIM 90 CU

Cod.: 8518 / EAN: 8435025785182



- » Wall chimney with tower in glossy black stainless steel
- » Big filtering surface
- » 5 extraction levels and booster
- » Inner shield 135 W Brushless Motor, BT4DC
- » Max / Min extraction rate: 852 / 271 m³/h
- » Lighting LED bar
- » Decorative premium stainless steel filters washable in dishwasher
- » A++** Energy efficiency class

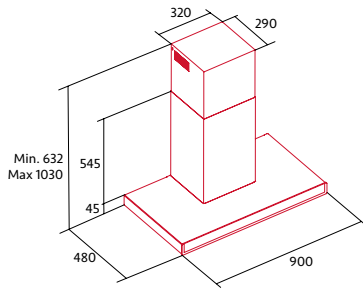

HOOD

NorBreeze FRIDA 90 CU

Cod.: 8521 / EAN: 8435025785212



- » Inclined glass wall hood with tower in glossy black stainless steel
- » Perimeter extraction
- » 5 extraction levels and booster
- » 135 W Brushless Motor, BT4DC
- » Max / Min extraction rate: 842 / 283 m³/h
- » Lighting LED bar
- » Non condensation filter
- » Metallic filters washable in dishwasher
- » A++** Energy efficiency class

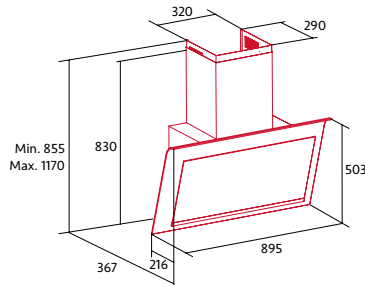

HOOD

NorBreeze FRIDA 80 CU

Cod.: 8522 / EAN: 8435025785229



- » Inclined glass wall hood with tower in glossy black stainless steel
- » Perimeter extraction
- » 5 extraction levels and booster
- » 135 W Brushless Motor, BT4DC
- » Max / Min extraction rate: 842 / 283 m³/h
- » Lighting LED bar
- » Non condensation filter
- » Metallic filters washable in dishwasher
- » A++** Energy efficiency class

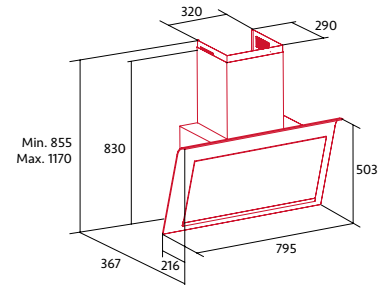

HOOD

NorBreeze DEIMOS 1000 RD

Cod.: 8523 / EAN: 8435025785236



- » Ceiling hood
- » Perimeter extraction
- » 5 extraction levels and booster
- » 135 W motor, BT4DC
- » Max / Min extraction rate: 800 / 260 m³/h*
- » Lighting LED bars
- » Filtros estándar metálicos lavables en el lavavajillas
- » Optional carbon filter accessory
- » Efficiency energy class A+**

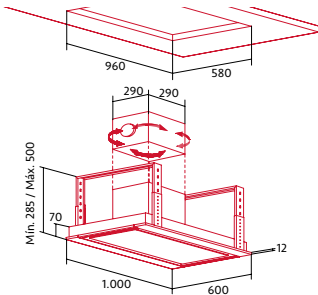

* net capacity / ** within the range A+++ to D

MULTIFUNCTION OVEN

NorChef MO 6610 RR

Cod.: 1757 / EAN: 8435025717572



- » 53 litres* Nsoft multifunction oven
- » Painted door and control panel in red color
- » Start/Stop
- » Nsoft multifunction with 10 functions
- » Nhome-baked function
- » Nclean Easy-To-Clean enamel
- » Ncomfort telescopic guides
- » A** Energy efficiency class

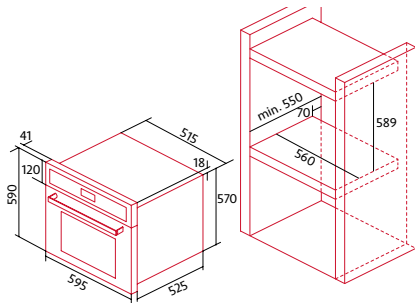

REFRIGERATORS

NorFrost HAIL 194 TNF RR

Cod.: 8584 / EAN: 8435025785847



- » 1,97m retro combi with red finish
- » Electronic temperature regulation
- » Red finish in all the refrigerator
- » Nchilly function in refrigerator and Nsubzero in freezer
- » Automatic refrigerator and freezer defrost
- » Refrigerator: 4 balconies and 4 glass shelves
- » Opening doors from left to right
- » Efficiency energy class E***

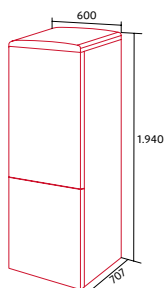

HOOD

NorBreeze SPIRIT RR

Cod.: 1756 / EAN: 8435025717565



- » Chimney wall hood
- » 3 extraction levels
- » 190 W motor
- » Max / Min extraction rate: 560 / 341,3 m³/h
- » Lighting LED
- » Standard metallic filters washable in dishwasher
- » Optional carbon filter accessory
- » Efficiency energy class B**

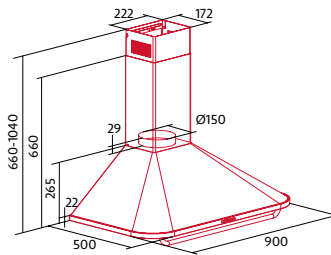

REFRIGERATORS

NorFrost HAIL 185 2TNF RR

Cod.: 8585 / EAN: 8435025785854



- » 1,83m retro combi with red finish
- » Electronic temperature regulation
- » Red finish in all the refrigerator
- » Nchilly function in refrigerator and Nsubzero in freezer
- » Automatic refrigerator and freezer defrost
- » Refrigerator: 4 balconies and 4 glass shelves
- » Opening doors from left to right
- » Efficiency energy class E***

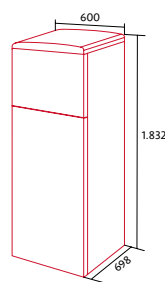

* net capacity / ** within the range A+++ to D / *** within the range A to C

HOOD

NorBreeze ISLA DEIMOS 1400 TWIN RF

Cod.: 8525 / EAN: 8435025785250



- » Ceiling hood
- » Perimeter extraction
- » 5 extraction levels and booster
- » 2 x 135 W motor, BT4DC
- » Max / Min extraction rate: 1600 / 400 m³/h
- » Lighting LED bars
- » Standard metallic filters washable in dishwasher
- » Optional carbon filter accessory
- » Efficiency energy class A+**

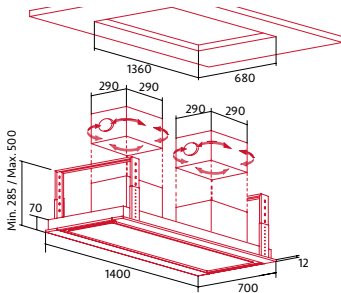

HOOD

NorBreeze ISLA DEIMOS X 1200 RF

Cod.: 8526 / EAN: 8435025785267



- » Ceiling hood
- » Perimeter extraction
- » 5 extraction levels and booster
- » 135 W motor, BT4DC
- » Max / Min extraction rate: 852 / 271 m³/h
- » Lighting LED bars
- » Standard metallic filters washable in dishwasher
- » Optional carbon filter accessory
- » Efficiency energy class A+**

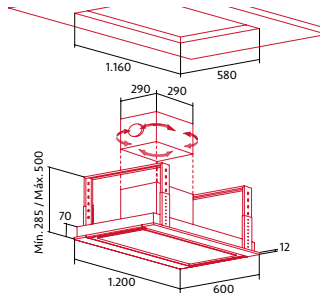

HOOD

NorBreeze ISLA DEIMOS 1000 RF

Cod.: 8527 / EAN: 8435025785274



- » Ceiling hood
- » Perimeter extraction
- » 5 extraction levels and booster
- » 135 W motor, BT4DC
- » Max / Min extraction rate: 852 / 271 m³/h
- » Lighting LED bars
- » Standard metallic filters washable in dishwasher
- » Optional carbon filter accessory
- » Efficiency energy class A+**

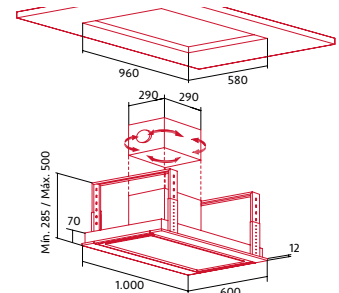

HOOD

NorBreeze ISLA CUBE GLASS ECO 60 BK

Cod.: 8545 / EAN: 8435025785458



- » Glass Box island hood
- » 4 extraction levels and booster
- » 130 W motor, BTDCA
- » Max / Min extraction rate: 820 / 200 m³/h
- » Lighting LED
- » Decorative premium stainless steel filters washable in dishwasher
- » Optional carbon filter accessory
- » Efficiency energy class A**

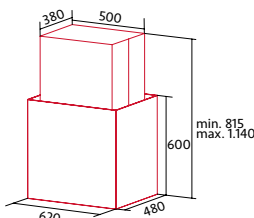

HOOD

NorBreeze ISLA CUBE GLASS ECO 60 WH

Cod.: 8546 / EAN: 8435025785465



- » Glass Box island hood
- » 4 extraction levels and booster
- » 130 W motor, BTDCA
- » Max / Min extraction rate: 820 / 200 m³/h
- » Lighting LED
- » Decorative premium stainless steel filters washable in dishwasher
- » Optional carbon filter accessory
- » Efficiency energy class A**

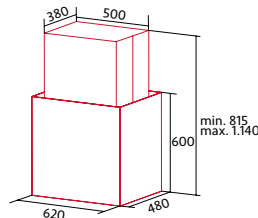

HOOD

NorBreeze ISLA SLIMOS 900

Cod.: 8393 / EAN: 8435025783935



- » Ceiling hood
- » Perimeter extraction
- » 4 extraction levels and booster
- » 130 W independent motor, BTDCA
- » Max / Min extraction rate: 750 / 200 m³/h
- » Lighting LED bars
- » Standard metallic filters washable in dishwasher
- » Optional carbon filter accessory
- » Accessory cable + 5m BTDCA (not included) Cod.: 02893005 / EAN 8422248074322
- » Efficiency energy class A**

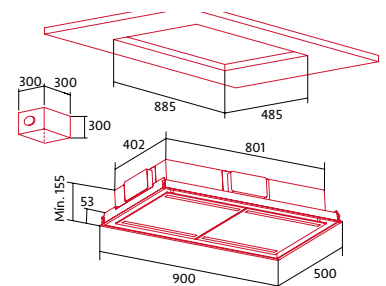

** within the range A+++ to D

HOOD

NorBreeze ISLA MIRAGE PREMIUM 120

Cod.: 8547 / EAN: 8435025785472



- » Box island hood
- » 4 extraction levels and booster
- » Inner shield 130 W motor, BTDCA
- » Max / Min extraction rate: 800 / 260 m³/h
- » Lighting LED
- » Decorative premium stainless steel filters washable in dishwasher
- » Optional carbon filter accessory
- » Efficiency energy class A+**

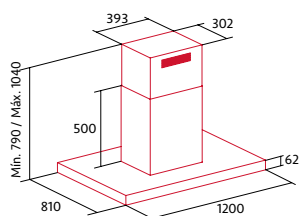

HOOD

NorBreeze ISLA MIRAGE PREMIUM 90

Cod.: 8548 / EAN: 8435025785489



- » Box island hood
- » 4 extraction levels and booster
- » Inner shield 130 W motor, BTDCA
- » Max / Min extraction rate: 800 / 260 m³/h
- » Lighting LED
- » Decorative premium stainless steel filters washable in dishwasher
- » Optional carbon filter accessory
- » Efficiency energy class A+**

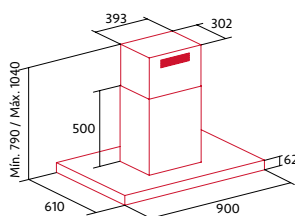

HOOD

NorBreeze ISLA SOL X / B

Cod.: 8375 / EAN: 8435025783751



- » Round island hood
- » Perimeter extraction
- » 2 extraction levels and booster
- » 240 W motor, BT2
- » Max / Min extraction rate: 810 / 300 m³/h
- » Lighting LED
- » Standard metallic filters washable in dishwasher
- » Optional carbon filter accessory
- » Efficiency energy class C**

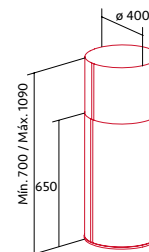

HOOD

NorBreeze CUBE GLASS ECO 70 BK

Cod.: 8528 / EAN: 8435025785281



- » Glass box wall hood
- » 3 extraction levels and booster
- » 260 W motor, BT3
- » Max / Min extraction rate: 820 / 340 m³/h
- » Lighting LED bar
- » Decorative stainless steel filters washable in dishwasher
- » Optional carbon filter accessory
- » Efficiency energy class A**

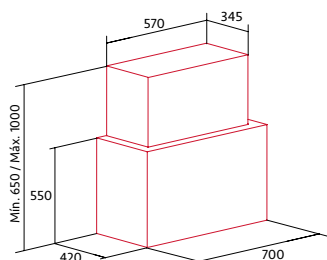

HOOD

NorBreeze CUBE GLASS ECO 70 WH

Cod.: 8529 / EAN: 8435025785298



- » Glass box wall hood
- » 3 extraction levels and booster
- » 260 W motor, BT3
- » Max / Min extraction rate: 820 / 340 m³/h
- » Lighting LED bar
- » Decorative stainless steel filters washable in dishwasher
- » Optional carbon filter accessory
- » Efficiency energy class A**

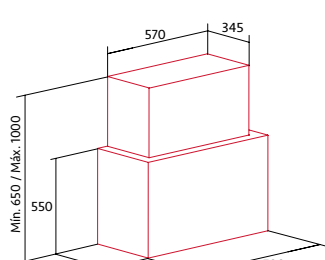

** within the range A+++ to D

HOOD

NorBreeze CUBE GLASS ECO 90 BK

Cod.: 8532 / EAN: 8435025785328



- » Glass box wall hood
- » 3 extraction levels and booster
- » 260 W motor, BT3
- » Max / Min extraction rate: 820 / 340 m³/h
- » Lighting LED bar
- » Decorative stainless steel filters washable in dishwasher
- » Optional carbon filter accessory
- » Efficiency energy class A**

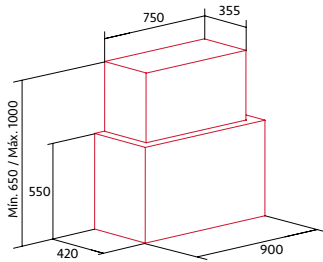

HOOD

NorBreeze CUBE GLASS ECO 90 WH

Cod.: 8533 / EAN: 8435025785335



- » Glass box wall hood
- » 3 extraction levels and booster
- » 260 W motor, BT3
- » Max / Min extraction rate: 820 / 340 m³/h
- » Lighting LED bar
- » Decorative stainless steel filters washable in dishwasher
- » Optional carbon filter accessory
- » Efficiency energy class A**

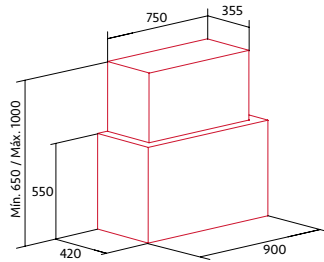

HOOD

NorBreeze SLIM 110 BK

Cod.: 8549 / EAN: 8435025785496



- » Box wall hood
- » 5 extraction levels and booster
- » Inner shield 135 W motor, BT4DC
- » Max / Min extraction rate: 852 / 271 m³/h
- » Lighting LED bar
- » Decorative premium stainless steel filters washable in dishwasher
- » Optional carbon filter accessory
- » Efficiency energy class A+**

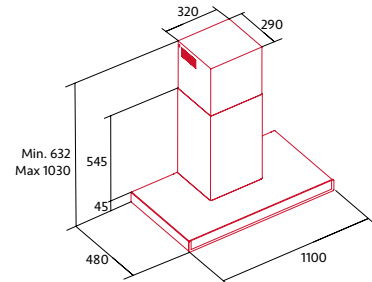

HOOD

NorBreeze SLIM 90 BK

Cod.: 8536 / EAN: 8435025785366



- » Box wall hood
- » 5 extraction levels and booster
- » Inner shield 135 W motor, BT4DC
- » Max / Min extraction rate: 852 / 271 m³/h
- » Lighting LED bar
- » Decorative premium stainless steel filters washable in dishwasher
- » Optional carbon filter accessory
- » Efficiency energy class A+**

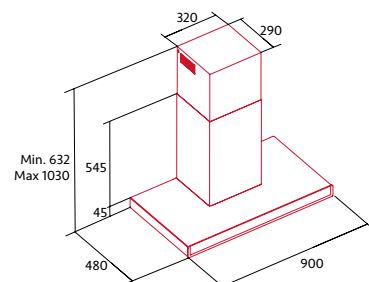

HOOD

NorBreeze SLIM 90 WH

Cod.: 8537 / EAN: 8435025785373



- » Box wall hood
- » 5 extraction levels and booster
- » Inner shield 135 W motor, BT4DC
- » Max / Min extraction rate: 852 / 271 m³/h
- » Lighting LED bar
- » Decorative premium stainless steel filters washable in dishwasher
- » Optional carbon filter accessory
- » Efficiency energy class A+**

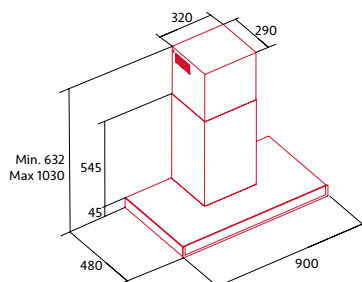

HOOD

NorBreeze SLIM 70 BK

Cod.: 8520 / EAN: 8435025785205



- » Box wall hood
- » 5 extraction levels and booster
- » Inner shield 135 W motor, BT4DC
- » Max / Min extraction rate: 852 / 271 m³/h
- » Lighting LED bar
- » Decorative premium stainless steel filters washable in dishwasher
- » Optional carbon filter accessory
- » Efficiency energy class A+**

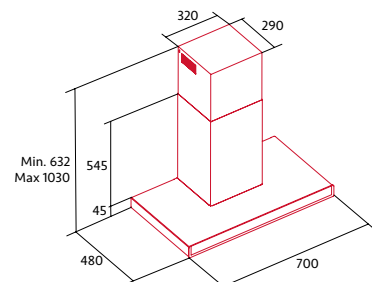

** within the range A+++ to D

HOOD

NorBreeze SLIM 70 WH

Cod.: 8563 / EAN: 8435025785632



- » Box wall hood
- » 5 extraction levels and booster
- » Inner shield 135 W motor, BT4DC
- » Max / Min extraction rate: 852 / 271 m³/h
- » Lighting LED bar
- » Decorative premium stainless steel filters washable in dishwasher
- » Optional carbon filter accessory
- » Efficiency energy class A+*

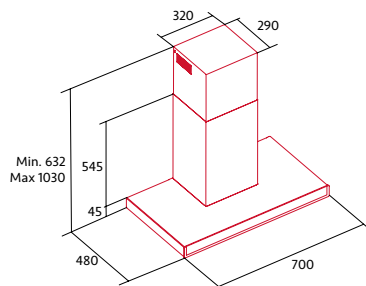

HOOD

NorBreeze LICEO 90 INOX

Cod.: 8556 / EAN: 8435025785564



- » Box wall hood
- » 3 extraction levels and booster
- » 260 W motor, BT3
- » Max / Min extraction rate: 850 / 340 m³/h
- » Lighting LED
- » Decorative stainless steel filters washable in dishwasher
- » Optional carbon filter accessory
- » Efficiency energy class A**

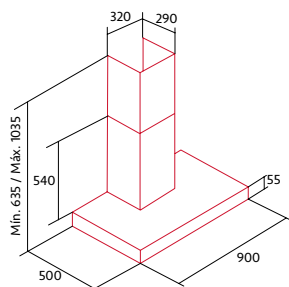

HOOD

NorBreeze LICEO 70 INOX

Cod.: 8557 / EAN: 8435025785571



- » Box wall hood
- » 3 extraction levels and booster
- » 260 W motor, BT3
- » Max / Min extraction rate: 850 / 340 m³/h
- » Lighting LED
- » Decorative stainless steel filters washable in dishwasher
- » Optional carbon filter accessory
- » Efficiency energy class A**

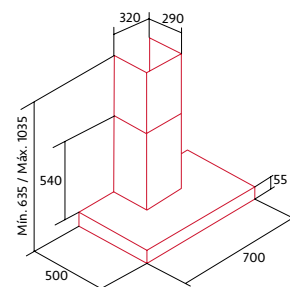

HOOD

NorBreeze SCALA 90 INOX

Cod.: 8559 / EAN: 8435025785595



- » Chimney wall hood
- » 3 extraction levels and booster
- » 260 W motor, BT3
- » Max / Min extraction rate: 850 / 340 m³/h
- » Lighting LED
- » Decorative stainless steel filters washable in dishwasher
- » Optional carbon filter accessory
- » Efficiency energy class A**

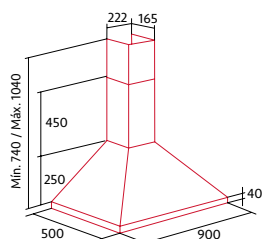

HOOD

NorBreeze SCALA 70 INOX

Cod.: 8561 / EAN: 8435025785618



- » Chimney wall hood
- » 3 extraction levels and booster
- » 260 W motor, BT3
- » Max / Min extraction rate: 850 / 340 m³/h
- » Lighting LED
- » Decorative stainless steel filters washable in dishwasher
- » Optional carbon filter accessory
- » Efficiency energy class A**

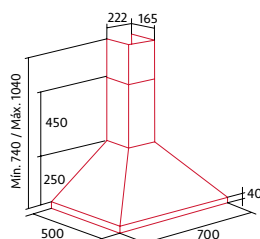

HOOD

NorBreeze SCALA 60 INOX

Cod.: 8562 / EAN: 8435025785625



- » Chimney wall hood
- » 3 extraction levels and booster
- » 260 W motor, BT3
- » Max / Min extraction rate: 850 / 340 m³/h
- » Lighting LED
- » Decorative stainless steel filters washable in dishwasher
- » Optional carbon filter accessory
- » Efficiency energy class A**

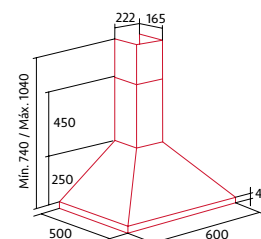

** within the range A+++ to D

HOOD

NorBreeze GALA L

Cod.: 8369 / EAN: 8435025783690



- » Box corner hood
- » 3 extraction levels and booster
- » 260 W motor, BT3
- » Max / Min extraction rate: 820 / 340 m³/h
- » Lighting LED bar
- » Decorative stainless steel filters washable in dishwasher
- » Optional carbon filter accessory
- » Efficiency energy class A**

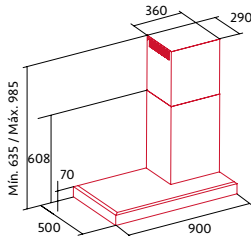

HOOD

NorBreeze GALA R

Cod.: 8370 / EAN: 8435025783706



- » Box corner hood
- » 3 extraction levels and booster
- » 260 W motor, BT3
- » Max / Min extraction rate: 820 / 340 m³/h
- » Lighting LED bar
- » Decorative stainless steel filters washable in dishwasher
- » Optional carbon filter accessory
- » Efficiency energy class A**

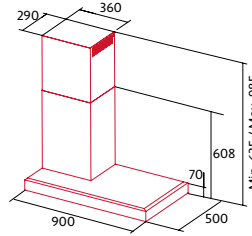

HOOD

NorBreeze GREGAL 90 WH NMOTION

Cod.: 8540 / EAN: 8435025785403



- » Integrated undercabinet hood
- » Perimeter extraction
- » 5 extraction levels and booster
- » 135 W motor, BT4DC
- » Max / Min extraction rate: 765 / 245 m³/h
- » Lighting LED bar
- » Standard metallic filters washable in dishwasher
- » Optional carbon filter accessory
- » Efficiency energy class A**

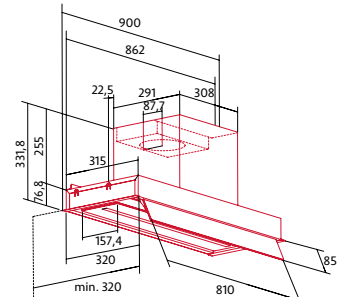

HOOD

NorBreeze GREGAL 60 WH NMOTION

Cod.: 8550 / EAN: 8435025785502



- » Integrated undercabinet hood
- » Perimeter extraction
- » 5 extraction levels and booster
- » 135 W motor, BT4DC
- » Max / Min extraction rate: 765 / 245 m³/h
- » Lighting LED bar
- » Standard metallic filters washable in dishwasher
- » Optional carbon filter accessory
- » Efficiency energy class A+**

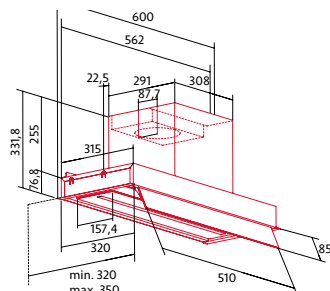

HOOD

NorBreeze ECLIPSE 90 BK

Cod.: 8551 / EAN: 8435025785519



- » Power pack
- » Perimeter extraction
- » 3 extraction levels and booster
- » 260 W motor, BT3
- » Max / Min extraction rate: 750 / 260 m³/h
- » Lighting LED bar
- » Standard metallic filters washable in dishwasher
- » Optional carbon filter accessory
- » Easy-to-install system
- » Efficiency energy class A**

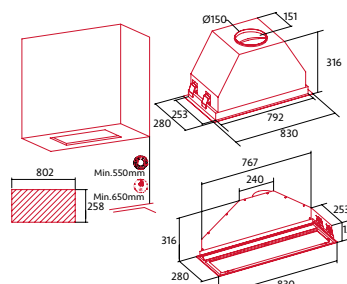

HOOD

NorBreeze ECLIPSE 60 BK

Cod.: 8552 / EAN: 8435025785526



- » Power pack
- » Perimeter extraction
- » 3 extraction levels and booster
- » 260 W motor, BT3
- » Max / Min extraction rate: 750 / 260 m³/h
- » Lighting LED bar
- » Standard metallic filters washable in dishwasher
- » Optional carbon filter accessory
- » Easy-to-install system
- » Efficiency energy class A**

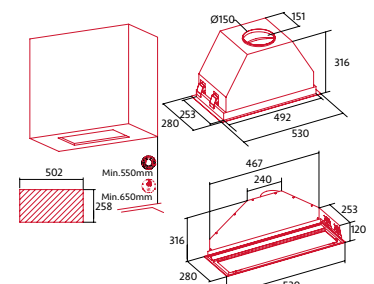

** within the range A+++ to D



HOOD

NorBreeze EXTENDER PLUS 90 X

Cod.: 1709 / EAN: 8435025717091



- » Built in telescopic hood
- » 2 extraction levels
- » Inner shield 240 W motor, BT2
- » Max / Min extraction rate: 645 / 300 m³/h
- » Lighting LED
- » Decorative stainless steel filters washable in dishwasher
- » Optional carbon filter accessory
- » Efficiency energy class C**

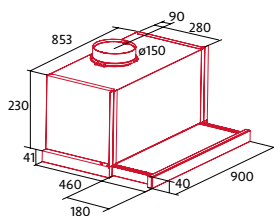

HOOD

NorBreeze EXTENDER PLUS 70 X

Cod.: 1715 / EAN: 8435025717152



- » Built in telescopic hood
- » 2 extraction levels
- » Inner shield 240 W motor, BT2
- » Max / Min extraction rate: 645 / 300 m³/h
- » Lighting LED
- » Decorative stainless steel filters washable in dishwasher
- » Optional carbon filter accessory
- » Efficiency energy class C**

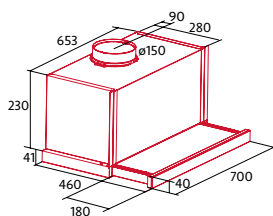

HOOD

NorBreeze EXTENDER PLUS 60 X

Cod.: 1716 / EAN: 8435025717169



- » Built in telescopic hood
- » 2 extraction levels
- » Inner shield 240 W motor, BT2
- » Max / Min extraction rate: 645 / 300 m³/h
- » Lighting LED
- » Decorative stainless steel filters washable in dishwasher
- » Optional carbon filter accessory
- » Efficiency energy class C**

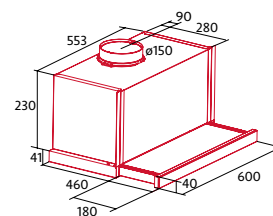

** within the range A+++ to D

HOOD

NorBreeze EXTENDER 900

Cod.: 1698 / EAN: 8435025716988



- » Built in telescopic hood
- » 2 extraction levels
- » 100 W motor, TF 2003
- » Max / Min extraction rate: 390 / 150 m³/h
- » Lighting LED
- » Decorative stainless steel filters washable in dishwasher
- » Optional carbon filter accessory
- » Efficiency energy class C**

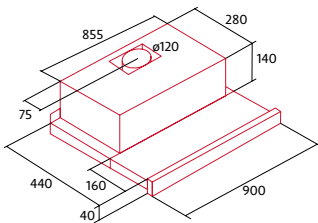

HOOD

NorBreeze EXTENDER 700

Cod.: 1699 / EAN: 8435025716995



- » Built in telescopic hood
- » 2 extraction levels
- » 100 W motor, TF 2003
- » Max / Min extraction rate: 390 / 150 m³/h
- » Lighting LED
- » Decorative stainless steel filters washable in dishwasher
- » Optional carbon filter accessory
- » Efficiency energy class C**

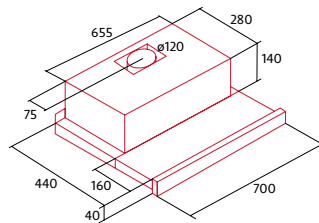

HOOD

NorBreeze EXTENDER 600

Cod.: 1700 / EAN: 8435025717008



- » Built in telescopic hood
- » 2 extraction levels
- » 100 W motor, TF 2003
- » Max / Min extraction rate: 390 / 150 m³/h
- » Lighting LED
- » Decorative stainless steel filters washable in dishwasher
- » Optional carbon filter accessory
- » Efficiency energy class C**

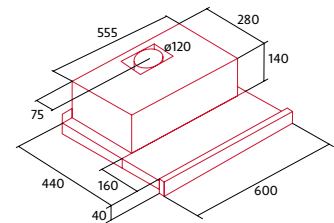

HOOD

NorBreeze EXTENDER 600 BK

Cod.: 1733 / EAN: 8435025717336



- » Built in telescopic hood
- » 2 extraction levels
- » 100 W motor, TF 2003
- » Max / Min extraction rate: 390 / 150 m³/h
- » Lighting LED
- » Decorative stainless steel filters washable in dishwasher
- » Optional carbon filter accessory
- » Efficiency energy class C**

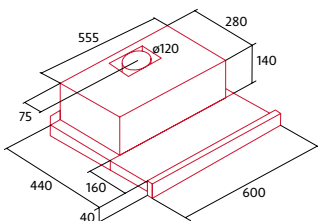

HOOD

NorBreeze EXTENDER 600 WH

Cod.: 1732 / EAN: 8435025717329



- » Built in telescopic hood
- » 2 extraction levels
- » 100 W motor, TF 2003
- » Max / Min extraction rate: 390 / 150 m³/h
- » Lighting LED
- » Decorative stainless steel filters washable in dishwasher
- » Optional carbon filter accessory
- » Efficiency energy class C**

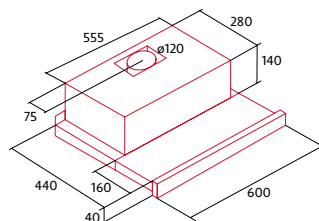

** within the range A+++ to D



HOBS

NorCook IH N9205 BK

Cod.: 4103 / EAN: 8435025741034



- » Frontal bevelled induction hob
- » Total cooking surface (87 x 38 cm)
- » Hidden Multi Slider Touch control panel
- » Nprecise. Individual power selector per pot, with 17 levels. Nboost+, 2 Boosters
- » Timer selector
- » Ncook: Melting, Keep warm, Simmering
- » Residual heat indicator
- » Max. Power: 11 kW

HOBS

NorCook IH N8205 BK

Cod.: 4104 / EAN: 8435025741041

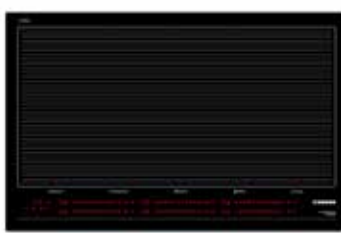

- » Frontal bevelled induction hob
- » Total cooking surface (75 x 38 cm)
- » Hidden Multi Slider Touch control panel
- » Nprecise. Individual power selector per pot, with 17 levels. Nboost+, 2 Boosters
- » Timer selector
- » Ncook: Melting, Keep warm, Simmering
- » Residual heat indicator
- » Max. Power: 11 kW

HOBS

NorCook IH N3200 BK

Cod.: 4110 / EAN: 8435025741102



- » Frontal bevelled induction hob
- » 2 Zone: Two modular of 21,5 cm (21,5 x 40 cm)
- » Touch control panel
- » Centralized power selector, with 9 levels. Nboost, 1 Booster
- » Timer selector
- » Ncook: Keep warm
- » Residual heat indicator
- » Max. Power: 3,7 kW

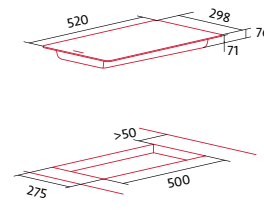
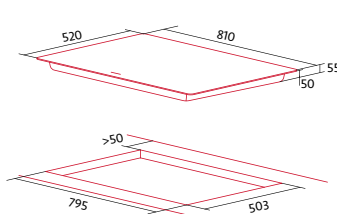
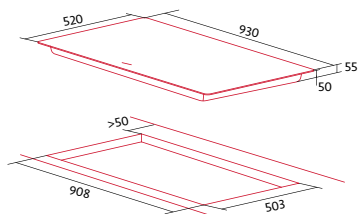

HOBS

NorCook IV N7502 BK

Cod.: 4114 / EAN: 8435025741140



- » Frontal bevelled mixed hob
- » 2 Zone: One of 27/21 cm and other of 22 cm diameter
- » Mono Slider Touch control panel
- » Centralized power selector, with 9 levels. Nboost, 1 Booster
- » Timer selector
- » Ncook: Keep warm
- » Residual heat indicator
- » Max. Power: 5,4 kW

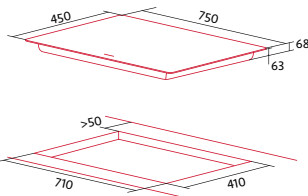

HOBS

NorCook IV N7503 BK

Cod.: 4115 / EAN: 8435025741157



- » Frontal bevelled mixed hob
- » 3 Zone: One of 27/21/14,5 cm, other of 22 and other of 22 cm diameter
- » Mono Slider Touch control panel
- » Centralized power selector, with 9 levels. Nboost, 1 Booster
- » Timer selector
- » Ncook: Keep warm
- » Residual heat indicator
- » Max. Power: 6,4 kW

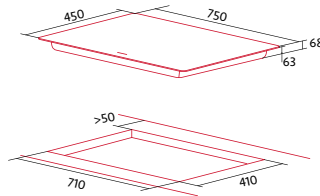

HOBS

NorCook VH N7502

Cod.: 4117 / EAN: 8435025741171



- » Frontal bevelled ceramic hob
- » 2 Zone: One of 27/21 cm and other of 18 cm diameter
- » Touch control panel
- » Centralized power selector, with 9 levels
- » Residual heat indicator
- » Max. Power: 4,2 kW

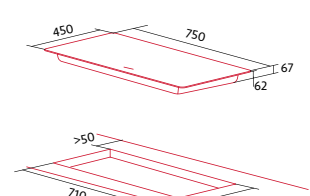

HOBS

NorCook IH N6404 BK

Cod.: 4107 / EAN: 8435025741072



- » Frontal bevelled induction hob
- » 4 Zone: Each one of 21,5 cm, can be combined in two modular zones (21,5 x 40 cm)
- » Hidden Mono Slider Touch control panel
- » Centralized power selector, with 9 levels. Nboost, 1 Booster
- » Timer selector
- » Ncook: Keep warm
- » Residual heat indicator
- » Max. Power: 7,4 kW

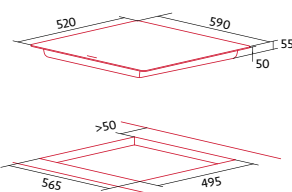

HOBS

NorCook IH N7003 BK

Cod.: 4126 / EAN: 8435025741263



- » Frontal bevelled induction hob
- » 3 Zone: One of 22 cm, other two of 18 cm diameter
- » Mono Slider Touch control panel
- » Centralized power selector, with 9 levels. Nboost, 1 Booster
- » Timer selector
- » Ncook: Keep warm
- » Residual heat indicator
- » Max. Power: 5,8 kW

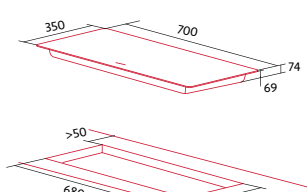

HOBS

NorCook IH N7703 BK

Cod.: 4111 / EAN: 8435025741119



- » Frontal bevelled induction hob
- » 3 Zone: One of 27 cm, other of 22 cm and other of 18 cm diameter
- » Touch control panel
- » Centralized power selector, with 9 levels. Nboost, 1 Booster
- » Timer selector
- » Residual heat indicator
- » Max. Power: 6,7 kW

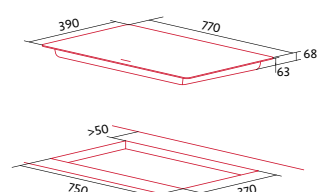

HOBS

NorCook IH N7502 BK

Cod.: 4112 / EAN: 8435025741126



- » Frontal bevelled induction hob
- » 2 Zone: One of 27 cm and other of 22 cm diameter
- » Mono Slider Touch control panel
- » Centralized power selector, with 9 levels. Nboost, 1 Booster
- » Timer selector
- » Ncook: Keep warm
- » Residual heat indicator
- » Max. Power: 6 kW

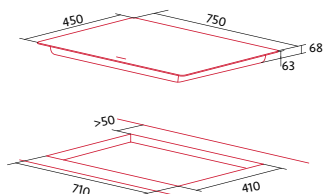

HOBS

NorCook IH N5902 BK

Cod.: 4113 / EAN: 8435025741133



- » Frontal bevelled induction hob
- » 2 Zone: One of 22 cm and other of 18 cm diameter
- » Touch control panel
- » Centralized power selector, with 9 levels. Nboost, 1 Booster
- » Timer selector
- » Residual heat indicator
- » Max. Power: 3,7 kW

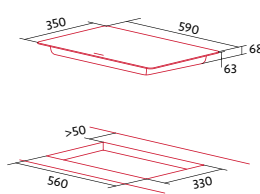

GAS HOBS

NorCook GH 8630 GBK

Cod.: 4122 / EAN: 8435025741225



- » 3 Cast iron independent pan supports on tempered glass surface
- » Two high efficiency (5 kW) triple ring burner, and one auxiliary burner (1,5kW) in brass colour
- » Illuminated frontal controls
- » Nselect power level
- » Nconnect cooker hood connectivity
- » Nspark. Electronic start-up built into control
- » Nflame. Gas shut-off safety system
- » For natural gas or butane gas (nozzles included)
- » Total gas power: 11,5 kW

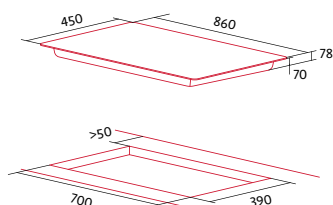

GAS HOBS

NorCook GH 7830 GBK

Cod.: 4123 / EAN: 8435025741232



- » 3 Cast iron independent pan supports on tempered glass surface
- » Two high efficiency (5 kW) triple ring burner, and one auxiliary burner (1,5kW) in brass colour
- » Frontal controls
- » Nconnect cooker hood connectivity
- » Nspark. Electronic start-up built into control
- » Nflame. Gas shut-off safety system
- » For natural gas or butane gas (nozzles included)
- » Total gas power: 11,5 kW

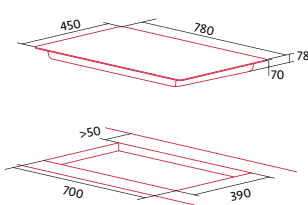

GAS HOBS

NorCook GH 7820 GBK

Cod.: 4124 / EAN: 8435025741249



- » 3 Cast iron independent pan supports on tempered glass surface
- » Two high efficiency (5 kW) triple ring burner
- » Frontal controls
- » Nconnect cooker hood connectivity
- » Nspark. Electronic start-up built into control
- » Nflame. Gas shut-off safety system
- » For natural gas or butane gas (nozzles included)
- » Total gas power: 10 kW

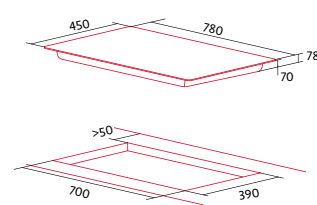

GAS HOBS

NorCook GH 7320 GBK

Cod.: 4125 / EAN: 8435025741256



- » 3 Cast iron independent pan supports on tempered glass surface
- » Two high efficiency (5 kW) triple ring burner
- » Frontal controls
- » Nconnect cooker hood connectivity
- » Nspark. Electronic start-up built into control
- » Nflame. Gas shut-off safety system
- » For natural gas or butane gas (nozzles included)
- » Total gas power: 10 kW

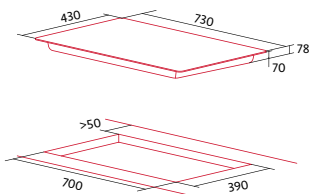

GAS HOBS

NorCook GH N3010 GBK

Cod.: 4121 / EAN: 8435025741218

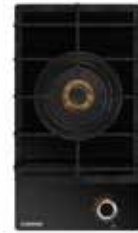

- » 1 Cast iron independent pan supports on ceramic glass surface
- » One high efficiency (5 kW) triple ring burner
- » Frontal controls
- » Nspark. Electronic start-up built into control
- » Nflame. Gas shut-off safety system
- » For natural gas or butane gas (nozzles included)
- » Total gas power: 6 kW

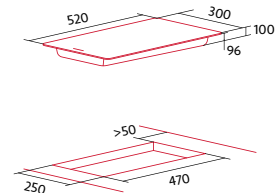

GAS HOBS

NorCook GCI 59

Cod.: 3914 / EAN: 8435025739147



- » 3 Cast iron independent pan supports on tempered glass surface
- » One high efficiency (3,5 kW) triple ring burner, one super-fast burner (3kW), two semi-fast burner (1,7kW) and one auxiliary burner (1kW)
- » Frontal controls
- » Nspark. Electronic start-up built into control
- » Nflame. Gas shut-off safety system
- » For natural gas or butane gas (nozzles included)
- » Total gas power: 10,9 kW

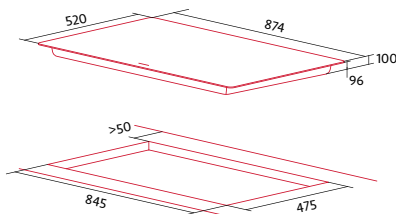

GAS HOBS

NorCook GCI 57

Cod.: 3910 / EAN: 8435025739109



- » 3 Cast iron independent pan supports on tempered glass surface
- » One high efficiency (3,5 kW) triple ring burner, one super-fast burner (3kW), two semi-fast burner (1,7kW) and one auxiliary burner (1kW)
- » Frontal controls
- » Nspark. Electronic start-up built into control
- » Nflame. Gas shut-off safety system
- » For natural gas or butane gas (nozzles included)
- » Total gas power: 10,9 kW

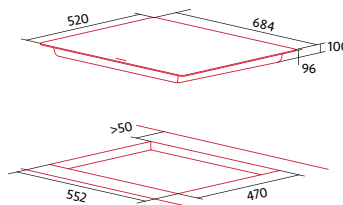

GAS HOBS

NorCook GCI 316

Cod.: 4015 / EAN: 8435025740150



- » 3 Cast iron independent pan supports on tempered glass surface
- » One high efficiency (3,5 kW) triple ring burner, two semi-fast burner (1,7kW) and one auxiliary burner (1kW)
- » Frontal controls
- » Nspark. Electronic start-up built into control
- » Nflame. Gas shut-off safety system
- » For natural gas or butane gas (nozzles included)
- » Total gas power: 7,9 kW

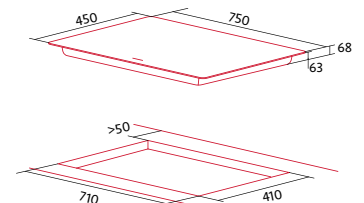

COOKWARE

NorCook STEAMCHEF

Cod.: 1368 / EAN: 8435025713680



- » Tray for steam cooking in stainless steel
- » Steam outlet valve regulation to cook in a quick way or at low temperature
- » Thermometer to cook with the exact temperature
- » High Resistant glass lid
- » Aromatic herbs infuse tank
- » Compact base diffuser of high efficiency
- » Two inner trays to cook directly with steam or with its own juice
- » Silicone handles resistant up to 200°C
- » 7 liters volume tray
- » 1,5 liters volume inner trays

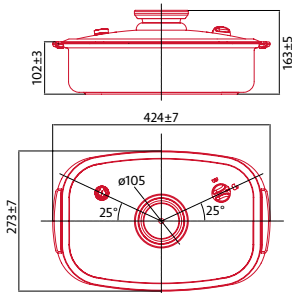

COOKWARE

NorCook NBBQ

Cod.: 1400 / EAN: 8435025714007



- » Cast iron grill
- » Rectangular base for total surface or flex induction
- » Nonstick surface
- » Ideal for: searing meat and fish with minimum of fat. Grilling vegetables and fruit
- » Two cooking zones grill or griddle
- » Dimensions: 432x228mm

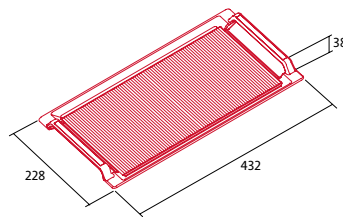

REFRIGERATOR

NorFrost TUNDRA TNF 177 BI
Cod.: 8586 / EAN: 8435025785861



- » 1,77m fridge built-in TOTAL No Frost
- » Electronic temperature regulation
- » Built-In Side by Side possibility with our model NorFrost ICE 177 TNF BI
- » Metallic interior finishes
- » Nchilly function
- » Nsave function
- » 5 balconies and 4 glass shelves with a drawer for fruits and vegetables
- » Reversible doors
- » Efficiency energy class F***

FREEZER

NorFrost ICE TNF 177 BI
Cod.: 8587 / EAN: 8435025785878



- » 1,77m freezer built-in TOTAL No Frost
- » Electronic temperature regulation
- » Built-in Side by Side possibility with our model NorFrost TUNDRA 177 TNF BI
- » Metallic interior finishes
- » Nchilly function
- » Reversible doors
- » Efficiency energy class F***

REFRIGERATOR

NorFrost HAIL TNF 177 BI
Cod.: 8579 / EAN: 843502578793



- » 1,77m built-in combi
- » Electronic temperature regulation
- » Inverter motor
- » Metallic interior finishes
- » Nchilly function in refrigerator and Nsubzero in freezer
- » Nsave function
- » Automatic refrigerator and freezer defrost
- » Refrigerator: 3 drawers and 5 glass shelves with a drawer for fruits and vegetables
- » Reversible doors
- » Efficiency energy class E***

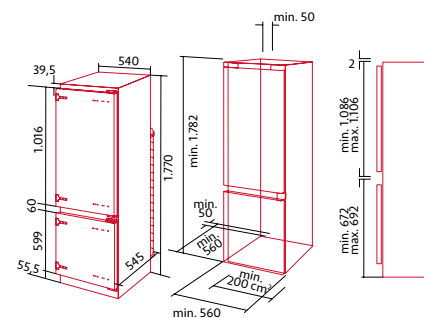
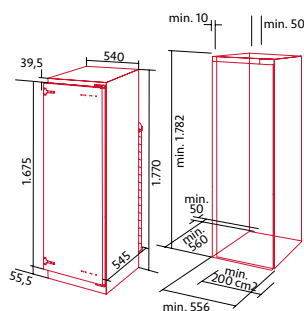
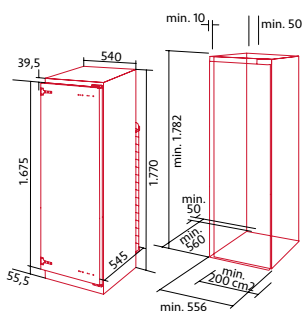

*** within the range A to G

DISHWASHERS

NorCare DW6142 I SL

Cod.: 8708 / EAN: 8435025787087



- » 60 cm built in dishwasher with 14 place settings capacity
- » Triple security system: overheating, anti-overflow and water leak
- » Special programs: Nquick +, Ncare y Nfresh
- » Functions: Deferred programming up to 24 hours. Nby2, half-load possibility and recharge de dishes
- » Display with: Deferred programming up to 24 hours, remaining time, selected program, salt, rinse aid and selected functions
- » Top and bottom baskets with folding supports and third tray
- » Inverter Motor BLDC
- » Turbo drying system
- » Efficiency energy class C***

DISHWASHERS

NorCare DW6141 I SL

Cod.: 8709 / EAN: 8435025787094



- » 60 cm built in dishwasher with 14 place settings capacity
- » Triple security system: overheating, anti-overflow and water leak
- » Special programs: Nquick +, Ncare y Nfresh
- » Functions: Deferred programming up to 24 hours. Nby2, half-load possibility and recharge de dishes
- » Display with: Deferred programming up to 24 hours, remaining time, selected program, salt, rinse aid and selected functions
- » Turbo drying system
- » Nmove. Full integrated door
- » Top and bottom baskets with folding supports
- » Stainless steel control panel
- » Efficiency energy class D***

DISHWASHERS

NorCare DW4611 I SL

Cod.: 8710 / EAN: 8435025787100



- » 45 cm built in dishwasher with 10 place settings capacity
- » Triple security system: overheating, anti-overflow and water leak
- » Special programs: Nquick +, Ncare y Nfresh
- » Functions: Deferred programming up to 24 hours. Nby2, half-load possibility and recharge de dishes
- » Display with: Deferred programming up to 24 hours and remaining time and selected functions
- » Top and bottom baskets with folding supports
- » Stainless steel control panel
- » Efficiency energy class D***

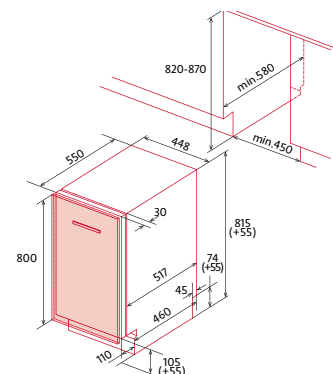
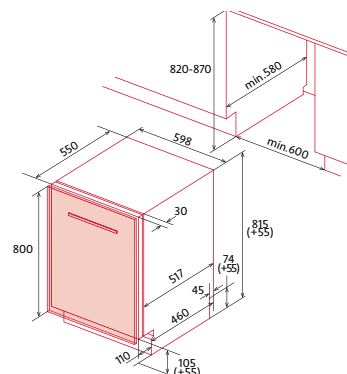
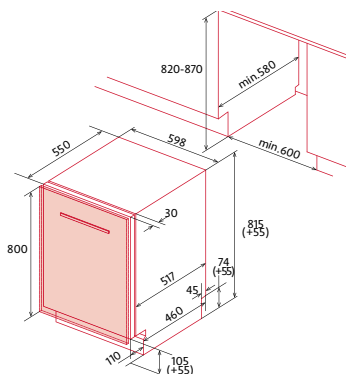

*** within the range A to C

WINECOOLER

NorCare V36 BK

Cod.: 4191 / EAN: 8422248101820



- » Built-in and column installation no frost wine cooler
- » No Frost technology
- » 2 independent temperature zones between 522°
- » Wooden shelves
- » Inner Led
- » Capacity: 36 bottles
- » Black glass door
- » Efficiency energy class G***
- » Electronic temperature regulation
- » Reversible door

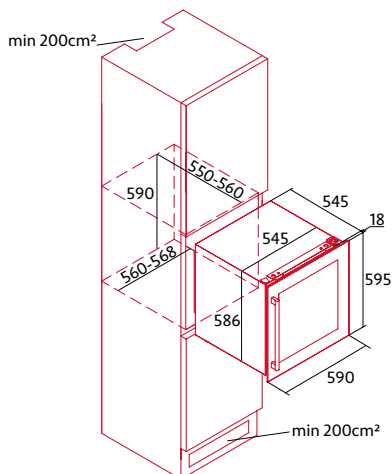

WINECOOLER

NorCare V28BK

Cod.: 4190 / EAN: 8422248101813



- » Built-in and column installation no frost wine cooler
- » No Frost technology
- » 2 independent temperature zones between 520°
- » Wooden shelves
- » Inner Led
- » Capacity: 28 bottles
- » Black glass door
- » Efficiency energy class G***
- » Electronic temperature regulation
- » Reversible door

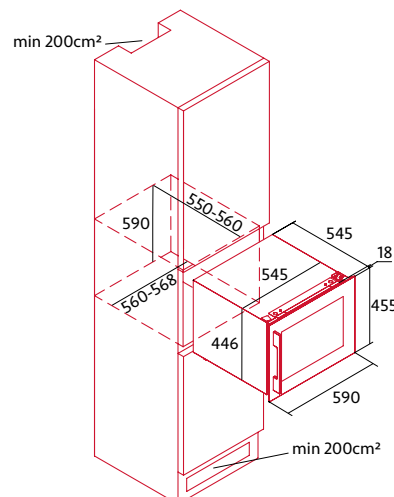

*** within the range A to G

TAPS

NorFlow BLACKBIRD BK

Cod.: 4095 / EAN: 8435025740952



- » 304 stainless steel fixing-tap with satin finish style
- » Removable and rotatory 360° curved high semi-professional spout
- » Handle control on the frontal of the tap
- » Water spray mechanism
- » Shower function
- » Ceramic cartridge included
- » Flexible connection tubes included

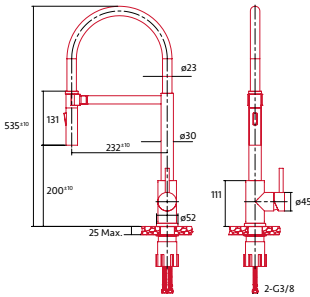

TAPS

NorFlow BLACKBIRD WH

Cod.: 4096 / EAN: 8435025740969



- » 304 stainless steel fixing-tap with satin finish style
- » Removable and rotatory 360° curved high semi-professional spout
- » Handle control on the frontal of the tap
- » Water spray mechanism
- » Shower function
- » Ceramic cartridge included
- » Flexible connection tubes included

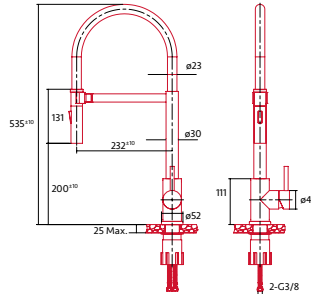

TAPS

NorFlow BLACKBIRD RD

Cod.: 4097 / EAN: 8435025740976



- » 304 stainless steel fixing-tap with satin finish style
- » Removable and rotatory 360° curved high semi-professional spout
- » Handle control on the frontal of the tap
- » Water spray mechanism
- » Shower function
- » Ceramic cartridge included
- » Flexible connection tubes included

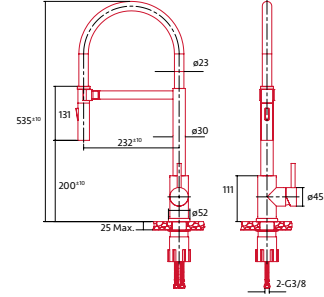

TAPS

NorFlow ROBIN BK

Cod.: 4098 / EAN: 8435025740983



- » 304 stainless steel fixing-tap with satin finish style
- » Rotatory 360° L shaped high spout
- » Handle control on the right side of the tap
- » Water spray mechanism
- » Ceramic cartridge included
- » Flexible connection tubes included

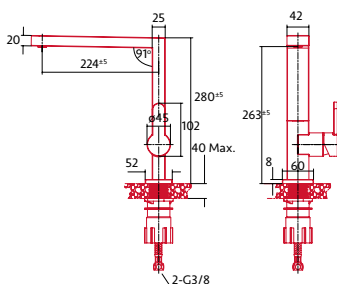

TAPS

NorFlow ROBIN SS

Cod.: 4099 / EAN: 8435025740990



- » 304 stainless steel fixing-tap with satin finish style
- » Rotatory 360° L shaped high spout
- » Handle control on the right side of the tap
- » Water spray mechanism
- » Ceramic cartridge included
- » Flexible connection tubes included

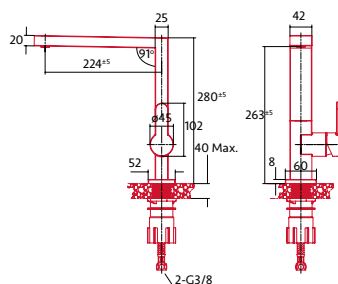

TAPS

NorFlow ROBIN CU

Cod.: 4100 / EAN: 8435025741003



- » 304 stainless steel fixing-tap with satin finish style
- » Rotatory 360° L shaped high spout
- » Handle control on the right side of the tap
- » Water spray mechanism
- » Ceramic cartridge included
- » Flexible connection tubes included

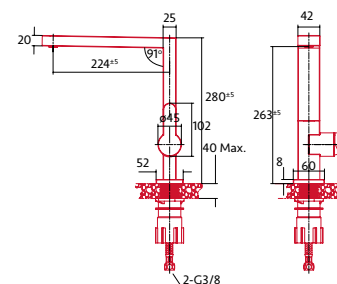

TAPS

NorFlow DENALI Extensible

Cod.: 3600 / EAN: 8435025736009



- » Stainless steel fixing-tap
- » Pull-out high nozzle
- » Handle control at the side of the tap
- » Water spray mechanism
- » Ceramic cartridge included
- » Flexible connection tubes included

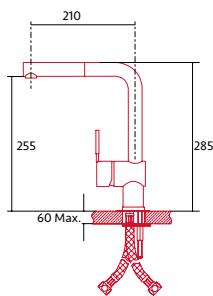

TAPS

NorFlow IBIS INOX

Cod.: 3558 / EAN: 8435025735583



- » Cast iron pull-out shower.
- » Chrome finishing
- » Handle control on the side of the tap
- » Water spray mechanism
- » Ceramic cartridge included
- » Flexible connection tubes included

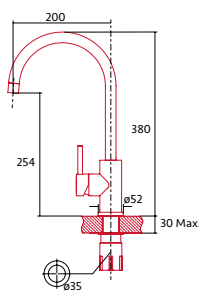

TAPS

NorFlow TUCÁN INOX

Cod.: 3552 / EAN: 8435025735521



- » Stainless steel fixing-tap
- » High nozzle
- » Handle control at the side of the tap
- » Water spray mechanism
- » Ceramic cartridge included
- » Flexible connection tubes included

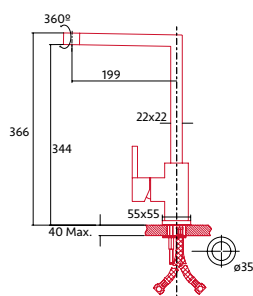

TAPS

NorFlow TUCÁN R

Cod.: 3589 / EAN: 8435025735897



- » Cast iron fixing-tap
- » 180° collapsible nozzle tap
- » Chrome finishing
- » Handle control at the side of the tap
- » Water spray mechanism
- » Ceramic cartridge included
- » Flexible connection tubes included

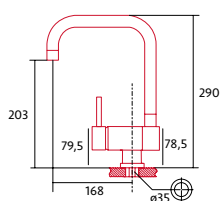

TOP MOUNT SINK

NorGranite 100.50 1B 1/2B 1D WH

Cod.: 4069 / EAN: 8435025740693



- » Granite built-in top mount sink
- » 1 + 1/2 square bowls
- » Sink with pre-hole mark for tap
- » Drainpipe with round 3 1/2" valve
- » Included accessories: round valves, tap covers, syphon and overflow tube

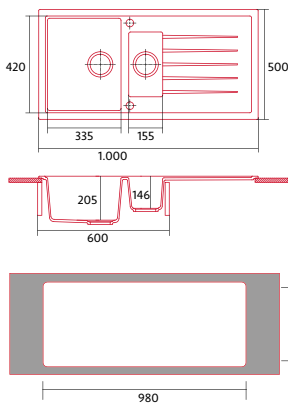

TOP MOUNT SINK

NorGranite 100.50 1B 1/2B 1D BK

Cod.: 4067 / EAN: 8435025740679



- » Granite built-in top mount sink
- » 1 + 1/2 square bowls
- » Sink with pre-hole mark for tap
- » Drainpipe with round 3 1/2" valve
- » Included accessories: round valves, tap covers, syphon and overflow tube

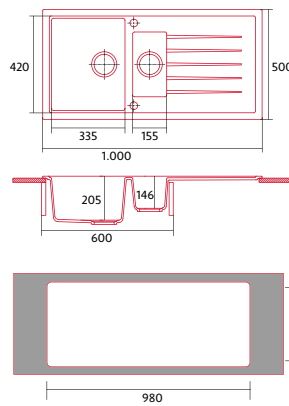

TOP MOUNT SINK

NorGranite 100.50 1B 1/2B 1D BG

Cod.: 4068 / EAN: 8435025740686



- » Granite built-in top mount sink
- » 1 + 1/2 square bowls
- » Sink with pre-hole mark for tap
- » Drainpipe with round 3 1/2" valve
- » Included accessories: round valves, tap covers, syphon and overflow tube

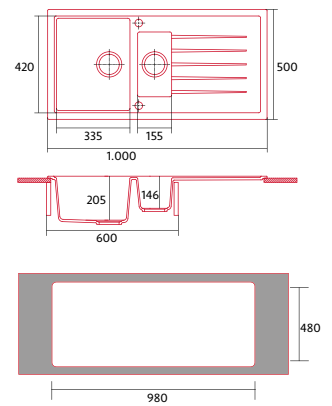

TOP MOUNT SINK

NorGranite 86.50 2B WH

Cod.: 4072 / EAN: 8435025740723



- » Granite built-in top mount sink
- » 2 square bowl
- » Sink with pre-hole mark for tap
- » Drainpipe with round 3 1/2" valve
- » Included accessories: round valves, tap covers, syphon and overflow tube

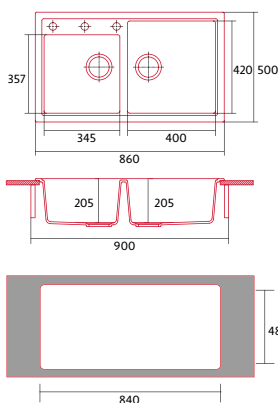

TOP MOUNT SINK

NorGranite 86.50 2B BK

Cod.: 4070 / EAN: 8435025740709



- » Granite built-in top mount sink
- » 2 square bowl
- » Sink with pre-hole mark for tap
- » Drainpipe with round 3 1/2" valve
- » Included accessories: round valves, tap covers, syphon and overflow tube

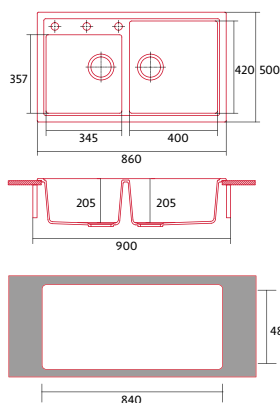

TOP MOUNT SINK

NorGranite 86.50 2B BG

Cod.: 4071 / EAN: 8435025740716



- » Granite built-in top mount sink
- » 2 square bowl
- » Sink with pre-hole mark for tap
- » Drainpipe with round 3 1/2" valve
- » Included accessories: round valves, tap covers, syphon and overflow tube

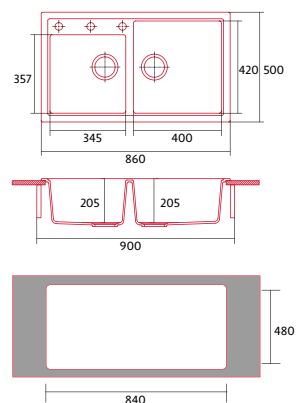

TOP MOUNT SINK

NorGranite 78.50 1B WH

Cod.: 4081 / EAN: 8435025740815



- » Granite built-in top mount sink
- » 1 square bowl
- » Sink with pre-hole mark for tap
- » Drainpipe with round 3 1/2" valve
- » Included accessories: round valves, tap covers, syphon and overflow tube

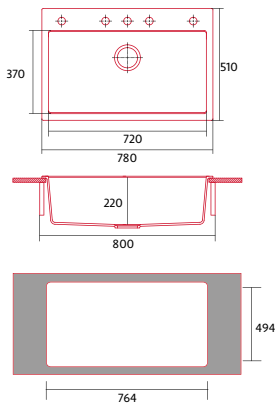

TOP MOUNT SINK

NorGranite 78.50 1B BK

Cod.: 4079 / EAN: 8435025740792



- » Granite built-in top mount sink
- » 1 square bowl
- » Sink with pre-hole mark for tap
- » Drainpipe with round 3 1/2" valve
- » Included accessories: round valves, tap covers, syphon and overflow tube

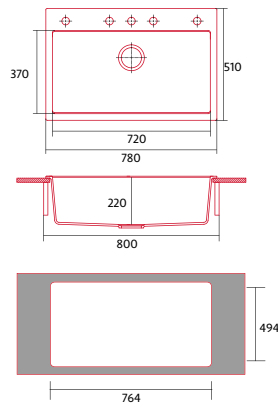

TOP MOUNT SINK

NorGranite 78.50 1B BG

Cod.: 4080 / EAN: 8435025740808



- » Granite built-in top mount sink
- » 1 square bowl
- » Sink with pre-hole mark for tap
- » Drainpipe with round 3 1/2" valve
- » Included accessories: round valves, tap covers, syphon and overflow tube

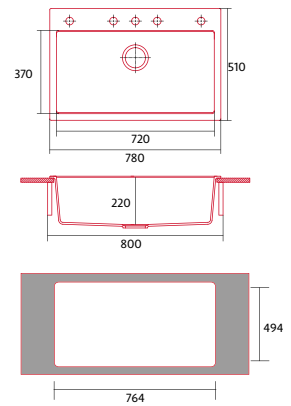

TOP MOUNT SINK

NorGranite 86.50 1B 1D WH

Cod.: 4063 / EAN: 8435025740631



- » Granite built-in top mount sink
- » 1 square bowl
- » Sink with pre-hole mark for tap
- » Drainpipe with round 3 1/2" valve
- » Included accessories: round valves, tap covers, syphon and overflow tube

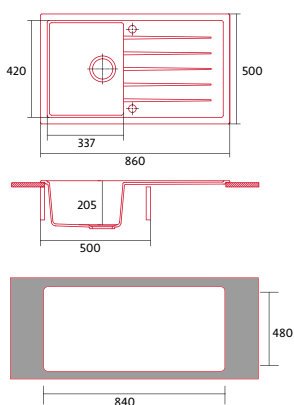

TOP MOUNT SINK

NorGranite 86.50 1B 1D BK

Cod.: 4061 / EAN: 8435025740617



- » Granite built-in top mount sink
- » 1 square bowl
- » Sink with pre-hole mark for tap
- » Drainpipe with round 3 1/2" valve
- » Included accessories: round valves, tap covers, syphon and overflow tube

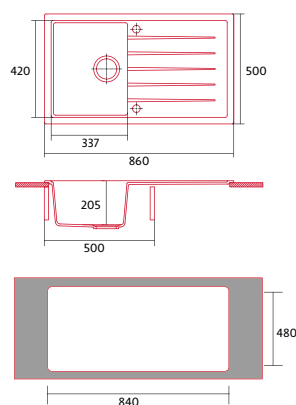

TOP MOUNT SINK

NorGranite 86.50 1B 1D BG

Cod.: 4062 / EAN: 8435025740624



- » Granite built-in top mount sink
- » 1 square bowl
- » Sink with pre-hole mark for tap
- » Drainpipe with round 3 1/2" valve
- » Included accessories: round valves, tap covers, syphon and overflow tube

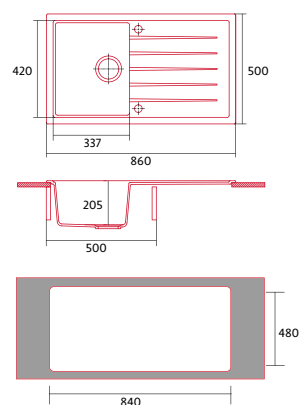

TOP MOUNT SINK

NorGranite 78.50 1B 1D WH

Cod.: 4060 / EAN: 8435025740600



- » Granite built-in top mount sink
- » 1 square bowl
- » Sink with pre-hole mark for tap
- » Drainpipe with round 3 1/2" valve
- » Included accessories: round valves, tap covers, syphon and overflow tube

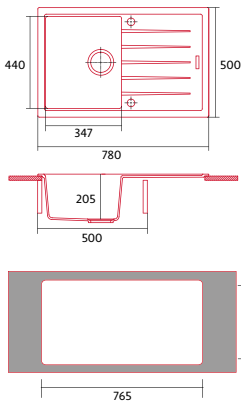

TOP MOUNT SINK

NorGranite 78.50 1B 1D BK

Cod.: 4058 / EAN: 8435025740587



- » Granite built-in top mount sink
- » 1 square bowl
- » Sink with pre-hole mark for tap
- » Drainpipe with round 3 1/2" valve
- » Included accessories: round valves, tap covers, syphon and overflow tube

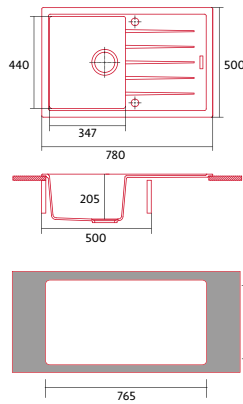

TOP MOUNT SINK

NorGranite 78.50 1B 1D BG

Cod.: 4059 / EAN: 8435025740594



- » Granite built-in top mount sink
- » 1 square bowl
- » Sink with pre-hole mark for tap
- » Drainpipe with round 3 1/2" valve
- » Included accessories: round valves, tap covers, syphon and overflow tube

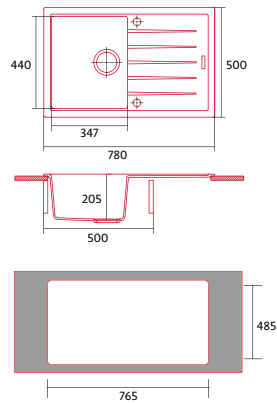

TOP MOUNT / UNDERMOUNT SINK

NorGranite 55.40 1B WH

Cod.: 4087 / EAN: 8435025740877



- » Granite built-in top mount/undermount sink
- » 1 square bowl
- » Sink with pre-hole mark for tap
- » Drainpipe with square 3 1/2" valve
- » Included accessories: round valves, tap covers, syphon and overflow tube

Top mount installation

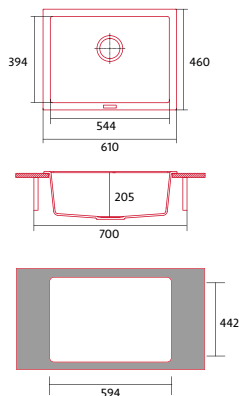

TOP MOUNT / UNDERMOUNT SINK

NorGranite 55.40 1B BK

Cod.: 4085 / EAN: 8435025740853



- » Granite built-in top mount/undermount sink
- » 1 square bowl
- » Sink with pre-hole mark for tap
- » Drainpipe with square 3 1/2" valve
- » Included accessories: round valves, tap covers, syphon and overflow tube

Undermount installation

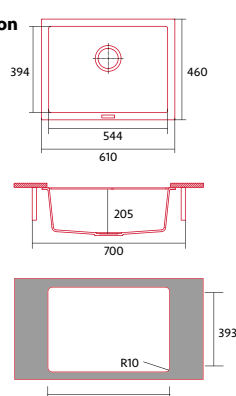

TOP MOUNT / UNDERMOUNT SINK

NorGranite 55.40 1B BG

Cod.: 4086 / EAN: 8435025740860



- » Granite built-in top mount/undermount sink
- » 1 square bowl
- » Sink with pre-hole mark for tap
- » Drainpipe with square 3 1/2" valve
- » Included accessories: round valves, tap covers, syphon and overflow tube

TOP MOUNT / UNDERMOUNT SINK

NorGranite 45.40 1B WH

Cod.: 4084 / EAN: 8435025740846



- » Granite built-in top mount/undermount sink
- » 1 square bowl
- » Sink with pre-hole mark for tap
- » Drainpipe with square 3 1/2" valve
- » Included accessories: round valves, tap covers, syphon and overflow tube

TOP MOUNT / UNDERMOUNT SINK

NorGranite 45.40 1B BK

Cod.: 4082 / EAN: 8435025740822



- » Granite built-in top mount/undermount sink
- » 1 square bowl
- » Sink with pre-hole mark for tap
- » Drainpipe with square 3 1/2" valve
- » Included accessories: round valves, tap covers, syphon and overflow tube

TOP MOUNT / UNDERMOUNT SINK

NorGranite 45.40 1B BG

Cod.: 4083 / EAN: 8435025740839



- » Granite built-in top mount/undermount sink
- » 1 square bowl
- » Sink with pre-hole mark for tap
- » Drainpipe with square 3 1/2" valve
- » Included accessories: round valves, tap covers, syphon and overflow tube

Top mount installation

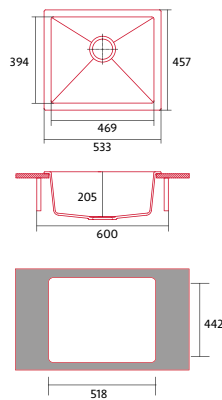

Undermount installation

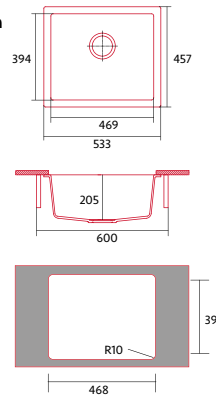

TOP MOUNT / UNDERMOUNT SINK

NorGranite 40.40 1B WH

Cod.: 4090 / EAN: 8435025740907



- » Granite built-in top mount/undermount sink
- » 1 square bowl
- » Sink with pre-hole mark for tap
- » Drainpipe with square 3 1/2" valve
- » Included accessories: round valves, tap covers, syphon and overflow tube

TOP MOUNT / UNDERMOUNT SINK

NorGranite 40.40 1B BK

Cod.: 4088 / EAN: 8435025740884



- » Granite built-in top mount/undermount sink
- » 1 square bowl
- » Sink with pre-hole mark for tap
- » Drainpipe with square 3 1/2" valve
- » Included accessories: round valves, tap covers, syphon and overflow tube

TOP MOUNT / UNDERMOUNT SINK

NorGranite 40.40 1B BG

Cod.: 4089 / EAN: 8435025740891



- » Granite built-in top mount/undermount sink
- » 1 square bowl
- » Sink with pre-hole mark for tap
- » Drainpipe with square 3 1/2" valve
- » Included accessories: round valves, tap covers, syphon and overflow tube

Top mount installation

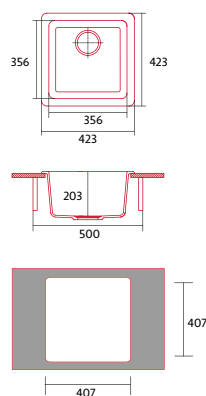

Undermount installation

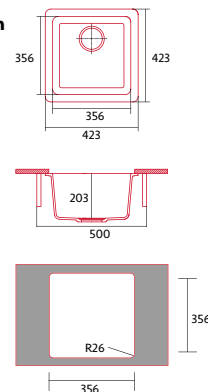

TOP MOUNT SINK

NorGranite Oval 51.20 1B WH

Cod.: 4078 / EAN: 8435025740785



- » Granite built-in top mount sink
- » 1 round bowl
- » Sink with pre-hole mark for tap
- » Drainpipe with square 3 1/2" valve
- » Included accessories: round valves, tap covers, syphon and overflow tube

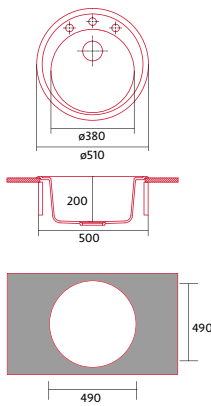

TOP MOUNT SINK

NorGranite Oval 51.20 1B BK

Cod.: 4076 / EAN: 8435025740761



- » Granite built-in top mount sink
- » 1 round bowl
- » Sink with pre-hole mark for tap
- » Drainpipe with square 3 1/2" valve
- » Included accessories: round valves, tap covers, syphon and overflow tube

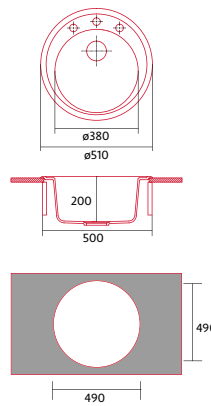

TOP MOUNT SINK

NorGranite Oval 51.20 1B BG

Cod.: 4077 / EAN: 8435025740778



- » Granite built-in top mount sink
- » 1 round bowl
- » Sink with pre-hole mark for tap
- » Drainpipe with square 3 1/2" valve
- » Included accessories: round valves, tap covers, syphon and overflow tube

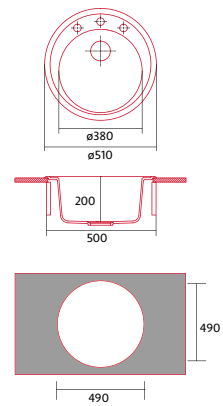

UNDERMOUNT SINK

NorAce 70.40 1C R10 CP

Cod.: 4093 / EAN: 8435025740938



- » Built-in undermount sink
- » 1 square bowl
- » Hidden waste with square 3 1/2" valve
- » Included accessories: square valve, syphon and overflow tube

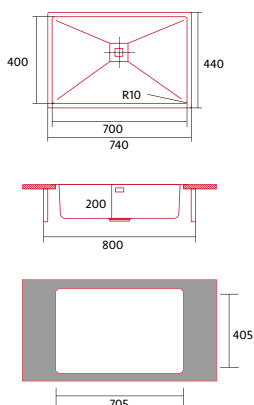

UNDERMOUNT SINK

NorAce 50.40 1C R10 CP

Cod.: 4091 / EAN: 8435025740914



- » Built-in undermount sink
- » 1 square bowl
- » Hidden waste with square 3 1/2" valve
- » Included accessories: square valve, syphon and overflow tube

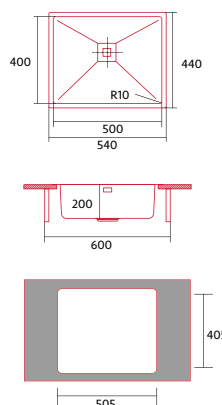

UNDERMOUNT SINK

NorAce 45.40 1C R10 CP

Cod.: 4092 / EAN: 8435025740921



- » Built-in undermount sink
- » 1 square bowl
- » Hidden waste with square 3 1/2" valve
- » Included accessories: square valve, syphon and overflow tube

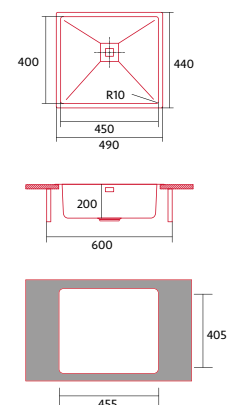

UNDERMOUNT SINK

NorAce 40.40 1C R10 CP

Cod.: 4094 / EAN: 8435025740945



- » Built-in undermount sink
- » 1 square bowl
- » Hidden waste with square 3 1/2" valve
- » Included accessories: square valve, syphon and overflow tube

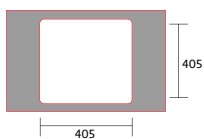
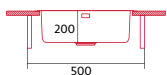
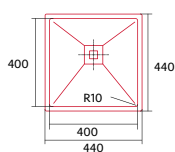

ACCESSORIES

ACCESSORY

BLACK Hidden Waste

Cod.: 1318 / EAN: 8435025713185



ACCESSORY

COPPER Hidden Waste

Cod.: 1320 / EAN: 8435025713208



ACCESSORY

STAINLESS STEEL Hidden Waste

Cod.: 1319 / EAN: 8435025713192

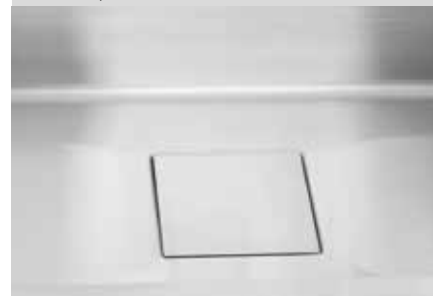





TECHNICAL INFORMATION

Code	2114	2118	2124	2115
EAN	8435025721142	8435025721180	8435025721241	8435025721159
Model	MO 6800 DB	MO 6800 SW	MO 6800 CU	MO 4800 DB
Type	Multifunction	Multifunction	Multifunction	Multifunction
Product fiche				
Energy efficiency index (IEE conventional/multifunction)	96	96	96	92,3
Energy efficiency Class	A	A	A	A
Conventional mode energy consumption (according to EN 50304/2009) [kWh]	0,86	0,86	0,86	0,69
Multifunction mode energy consumption (according to EN 50304/2009) [kWh]	0,79	0,79	0,79	0,67
Number of cavities	1	1	1	1
Cavity volume (l)	67	67	67	40
Dimensions				
Cavity height [mm]	595	595	595	455
Cavity width [mm]	595	595	595	595
Cavity depth [mm]	550	550	550	550
Cavity height [mm]	488	488	488	436
Cavity width [mm]	415	415	415	215
Cavity depth [mm]	330	330	330	410
Characteristics				
Finishing	Black / crhome	White / crhome	Black /cooper	Black / crhome
Soft Door closing	Yes	Yes	Yes	No
Tray levels	5	5	5	4
Fan	Yes	Yes	Yes	Yes
Number of lights	1	1	1	1
Controls				
Control type	Touch control	Touch control	Touch control	Touch control
Screen Technology	White LCD	White LCD	White LCD	White LCD
Working pilot light	Yes	Yes	Yes	Yes
Thermostat pilot light	Yes	Yes	Yes	Yes
Min. temperature [°C]	50	50	50	50
Max. Temperature TURBO [°C]	250	250	250	225
Min. Steam Temperature (°C)	No	No	No	No
Max. Steam Temperature (°C)	No	No	No	No
Cleaning				
Enamel	Easy cleaning Nclean enamel	Easy cleaning Nclean enamel	Easy cleaning Nclean enamel	Easy cleaning Nclean enamel
Type of cavity / lateral grill	Chromed, removable	Chromed, removable	Chromed, removable	Chromed, removable
Inner glass	Removable	Removable	Removable	Removable
Safety lock	Nchild	Nchild	Nchild	Nchild
Inner light	Yes	Yes	Yes	Yes
Fast preheat	Yes	Yes	Yes	Yes
Security				
Security Thermostat	Yes	Yes	Yes	Yes
Number of door glasses	2	2	2	2
Cooling fan	Yes	Yes	Yes	Yes
Electrical connection				
Grill power [W]	1900	1900	1900	1400
Microwave power [W]				
Top heating element power [W]	1000	1000	1000	
Underfloor element Power [W]	1200	1200	1200	1050
Back element Power [W]	2100	2100	2100	1600
Total Power [W]	3650	3650	3650	3280
Nominal voltage [V] / Mains frequency [Hz]	220-240 / 50	220-240 / 50	220-240 / 50	220-240 / 50
Light power [W]	15	15	15	15
Plug	No	No	No	No
Accessories				
Flat tray				
Deep tray	1	1	1	1
Steam tray				
Grill	1	1	1	1
Inner grill	1	1	1	1
Telescopic guides	1	1	1	1
Telescopic guides	100%	100%	100%	75%
Tray Handle	1	1	1	1
Removable tank (L)	No	No	No	No

2119	2127	2116	2120	2125	2117	2121
8435025721197	8435025721272	8435025721166	8435025721203	8435025721258	8435025721173	8435025721210
MO 4800 SW	MO 4800 CU	SO 4800 DB	SO 4800 SW	SO 4800 CU	MW 4800 DB	MW 4800 SW
Multifunction	Multifunction	Steamer	Steamer	Steamer	Microwaves	Microwaves
92,3	92,3	67,8	67,8	67,8		
A	A	A+	A+	A+		
0,69	0,69	0,59	0,59	0,59		
0,67	0,67	0,48	0,48	0,48		
1	1	1	1	1		
40	40	36	36	36	40	40
455	455	455	455	455	455	455
595	595	595	595	595	595	595
550	550	510	510	510	543	543
436	436	406	406	406	421	421
215	215	215	215	215	233	233
410	410	410	410	410	409	409
White / crhome	Black /cooper	Black / crhome	White / crhome	Black /cooper	Black	White
No	No	No	No	No	No	No
4	4	4	4	4	3	3
Yes	Yes	Yes	Yes	Yes	Yes	Yes
1	1	1	1	1	1	1
Touch control	Touch control	Touch control	Touch control	Touch control	Touch control	Touch control
White LCD	White LCD	White LCD	White LCD	White LCD	White LCD	White LCD
Yes	Yes	Yes	Yes	Yes	Yes	Yes
Yes	Yes	Yes	Yes	Yes	Yes	Yes
50	50	30	30	30	50	50
225	225	225	225	225	225	225
No	No	40	40	40	No	No
No	No	100	100	100	No	No
Easy cleaning Nclean enamel	Easy cleaning Nclean enamel	No	No	No	No	No
Chromed, removable	Chromed, removable	Embossed stainless steel	Embossed stainless steel	Embossed stainless steel	Embossed stainless steel	Embossed stainless steel
Removable	Removable	Removable	Removable	Removable	No	No
Nchild	Nchild	Nchild	Nchild	Nchild	Nchild	Nchild
Yes	Yes	Yes	Yes	Yes	Yes	Yes
Yes	Yes	Yes	Yes	Yes	No	No
Yes	Yes	Yes	Yes	Yes	Yes	Yes
2	2	3	3	3	2	2
Yes	Yes	Yes	Yes	Yes	Yes	Yes
1400	1400	1400	1400	1400	1400	1400
					1000	1000
1050	1050				1050	1050
1600	1600	1600	1600	1600	1600	1600
3280	3280	3050	3050	3050	2550	2550
220-240 / 50	220-240 / 50	220-240 / 50	220-240 / 50	220-240 / 50	220-240 / 50	220-240 / 50
15	15	15	15	15	15	15
No	No	No	No	No	No	No
1	1	1	1	1	1	1
		1	1	1		
1	1	1	1	1	1	1
1	1	1	1	1	1	1
1	1					
75%	75%					
1	1	1	1	1	1	1
No	No	1,2L	1,2L	1,2L	No	No

Code	2126	1757
EAN	8435025721265	8435025717572
Model	MW 4800 CU	MO 6610 RR
Type	Microwaves	Multifunction
Product fiche		
Energy efficiency index (IEE conventional/multifunction)		91,1
Energy efficiency Class		A
Conventional mode energy consumption (according to EN 50304/2009) [kWh]		0,74
Multifunction mode energy consumption (according to EN 50304/2009) [kWh]		0,71
Number of cavities		1
Cavity volume (l)	40	53
Dimensions		
Cavity height [mm]	455	590
Cavity width [mm]	595	595
Cavity depth [mm]	543	525
Cavity height [mm]	421	430
Cavity width [mm]	233	385
Cavity depth [mm]	409	320
Characteristics		
Finishing	Black	Red / chrome
Soft Door closing	No	No
Tray levels	3	4
Fan	Yes	Yes
Number of lights	1	1
Controls		
Control type	Touch control	Knobs
Screen Technology	White LCD	No
Working pilot light	Yes	Yes
Thermostat pilot light	Yes	Yes
Min. temperature [°C]	50	50
Max. Temperature TURBO [°C]	225	250
Min. Steam Temperature (°C)	No	No
Max. Steam Temperature (°C)	No	No
Cleaning		
Enamel	No	Easy cleaning Nclean enamel
Type of cavity / lateral grill	Embossed stainless steel	Chromed, removable
Inner glass	No	Removable
Safety lock	Nchild	No
Inner light	Yes	Yes
Fast preheat	No	No
Security		
Security Thermostat	Yes	Yes
Number of door glasses	2	3
Cooling fan	Yes	Yes
Electrical connection		
Grill power [W]	1400	900
Microwave power [W]	1000	
Top heating element power [W]		1350+900
Underfloor element Power [W]	1050	1000
Back element Power [W]	1600	2300
Total Power [W]	2550	2350
Nominal voltage [V] / Mains frequency [Hz]	220-240 / 50	220-240 / 50
Light power [W]	15	25
Plug	No	No
Accessories		
Flat tray		
Deep tray	1	1
Steam tray		
Grill	1	1
Inner grill	1	
Telescopic guides		1
Telescopic guides		80%
Tray Handle	1	
Removable tank (L)	No	No

Code	4053	4057
EAN	8435025740532	8435025740570
Model	NorChef MW 25 DG DB	NorChef MW 25 DG CU
Type (Built in / free standing)	Built in	Built in
Dimensions		
Cavity height [mm]	208	208
Cavity width [mm]	328	328
Cavity depth [mm]	369	369
External dimensions: height [mm]	388	388
External dimensions: width [mm]	595	595
External dimensions: depth [mm]	380	380
Characteristics		
Finishing	Dark black	Black /cooper
Door opening System	Lateral by touch	Lateral by touch
Cavity capacity [L]	25	25
Automatic menu	8	8
Nº of heating cooking programs	5	5
Nº of grill cooking programs	3	3
Noise level db[A]	63	63
Time-setting option	Yes	Yes
Control		
Display technology	White Electronic display	White Electronic display
Electronic timer	Yes	Yes
Manual timer	No	No
Start/Stop button	Yes	Yes
Door opening button	Push	Push
Timer [min]	95	95
Power selector	Yes	Yes
Function and temperature selector	Function selector	Function selector
Working indicator	LED display	LED display
Control type	Electronic	Electronic
Weight selector	Yes	Yes
Equipment		
Inside light	Yes	Yes
Cavity construction type	Stainless steel	Stainless steel
Opening door angle [degrees]	90	90
Functions		
Grill	Yes	Yes
Simultaneous grill + microwave	Yes	Yes
Defrosting, heating and cooking by food type	Yes	Yes
Memories	No	No
Quick start	Yes	Yes
Safety		
Safety thermostat	Yes	Yes
Safety automatic disconnection	Yes	Yes
Child safety lock	Yes	Yes
Door temperature	65	65
Nº of glasses in the door	1	1
Connection		
Grill power [kW]	1	1
Microwave power [W]	900	900
Total power [kW]	1,45	1,45
Voltage / Frequency [V/Hz]	230 / 50	230 / 50
Plug type	Schuko	Schuko
Accessories		
Rotatory removable glass	Yes	Yes
Diameter of glass dish [mm]	315	315
Built in frame	Included	Included
Ventilation kit	No	No

Code	2122	2123
EAN	8435025721227	8435025721234
Model	NorChef WP 1500 DB	NorChef WP 1500 SW
Type	Warming drawer	Warming drawer
Dimensions		
External dimensions: height [mm]	140	140
External dimensions: width [mm]	595	595
External dimensions: depth [mm]	525	525
Characteristics		
Finishing	Black	White
Control type	On/off button	On/off button
Thermostat	Yes	Yes
Fan assisted		
Operation indicator	Yes	Yes
Maximum temperature	70	70
Cooking at low temperature (slow cooking)	Yes	Yes
Leavening	Yes	Yes
Heating dishes	Yes	Yes
Keep warm	Yes	Yes
Usable volume (litres)	20	20
Chamber height	120	120
Safety front	Yes	Yes
Tempered glass	Yes	Yes
Connection		
Total power [W]	380-460	380-460
Voltage / Frequency [V/Hz]	220-240V/50-60Hz	220-240V/50-60Hz
Plug type	No	No

Code	8512	8515	8513	8516
EAN	8435025785120	8435025785151	8435025785137	8435025785168
Model	UNUM 90 DB NMOTION	CUADRATUM 90 DB NMOTION	CIRCUM 90 DB NMOTION	MISTRAL 90 DB
Type	inclined wall mounted	inclined wall mounted	inclined wall mounted	inclined wall mounted
Product fiche according to directives EU65/2014 - EN61591, EN60704-2-13, EN50564				
AEC (Annual Energy consumption) (kWh/annum)	21,9	20,4	23,4	18,3
EEL class (Energy Efficiency Class)	A++	A++	A++	A+++
FDE (Fluid Dynamic Efficiency)	40,3	40,3	39,3	40,3
FDE class (Fluid Dynamic Efficiency Class)	A	A	A	A
LE (Lighting Efficiency) (lux/W)	9,2	9,2	9,2	14,8
LE class (Lighting Efficiency Class)	E	E	E	D
GFE (Grease Filtering Efficiency)	62,3	60,2	58,6	60,2
GFE Class (Grease Filtering Efficiency class)	E	E	E	E
Air flow at minimum speed (m3/h)	265,2	282,8	270,8	282,8
Air flow at maximum speed (m3/h)	616,6	640,5	608,5	640,5
Air flow at intensive speed (TURBO) (m3/h)	843,6	841,6	851,6	841,6
Sound Power Level at minimum speed (dB)	46	46	46	46
Sound Power Level at maximum speed (dB)	64	64	65	64
Sound Power Level at intensive speed (TURBO) (dB)	69	69	70	69
Po (Power Consumption in off mode) (W)	0,46	0,46	0,46	0,46
Ps (Power Consumption in standby) (W)	-	-	-	-
Integration directive EU 66/2014				
f (Time Increase Factor)	0,5	0,5	0,6	0,5
EEL (Energy Efficiency Index)	33,8	32	36,5	29,5
QBEP (Flow Rate at Best Efficiency Point) (m3/h)	369,7	369,6	369,4	369,6
PBEP (Static Pressure Difference at Best Efficiency Point) (Pa)	314	314	308	314
WBEP (Electric Power Input at Best Efficiency Point) (W)	80	80	80,5	80
WL (Nominal Power Consumption of Lighting system) (W)	8	8	8	5
EMIDDLE (Average Illumination of Lighting system on Cooking surface) (lux)	74	74	74	74
External Dimensions				
Width (mm)	898	898	898	895
Depth (mm)	380	380	380	446
Total max height(mm)	1130	1130	1130	1175
Total min height(mm)	900	900	900	860
Outlet Diameter (mm)	150	150	150	150
Characteristics				
Motor	BT4DC	BT4DC	BT4DC	BT4DC
Extraction Levels	5+1	5+1	5+1	5+1
Motor Maximum Power Consumption	135	135	135	135
Maximum Pressure	357	357	357	357
Intensive Speed (TURBO) Pressure	365	365	365	365
Control Type	TCMD6i	TCMD6i	TCMD6i	TCD6i
Automatic shut-down timer	√	√	√	√
Electronic Filter Saturation Indicator	√	√	√	√
Filter Type	Decorative s. steel / A. metallic	Aluminum metallic	Aluminum metallic	Aluminum metallic
Anti-grease Filter Number	1+1	1+1	1+1	3
Inner Shield	-	-	-	-
Lighting				
Light Type	Ambient + SSLED	Ambient + SSLED	Ambient + SSLED	SSLED
Adjustable Intensity Lighting	√	√	√	√
Nº of Lamps	2+1	1+1	1+1	1
Installation				
Minimum height distance to a electric worktop hob (mm)	550	550	550	400
Minimum height distance to a gas worktop hob (mm)	650	650	650	650
Instalation with Outlet tube to the exterior / Recirculating	√ / √	√ / √	√ / √	√ / √
Easy Instalation System	√	√	√	√
Electric Connection				
Total Rush Power (W)	146	149	149	140
Rated Voltage (V)	220-240	220-240	220-240	220-240
Network Frequency (Hz)	50/60	50/60	50/60	50/60
Electrical Insulation Class	CLASS I	CLASS I	CLASS I	CLASS I
Plug	-	-	-	-
Accessories				
Upper Decorative tube Extension	-	-	-	-
Island Tube Enhancer	-	-	-	-
Check Valve	02832008	02832008	02832008	02832008
MAX PRO Metal Filter	-	-	-	-
Metal Filter	02800951/02800949	02800953/02800949	02800954/02800949	2811002
DUAL Filter (metal + active charcoal)	-	-	-	-
Active Charcoal Filter	02859318	02859318	02859318	02859318
Noiseless Flexible Duct	02893002	02893002	02893002	02893002
Recirculation kit (Piping kit + active charcoal filters)	-	-	-	-
Aluminium decorative cover	-	-	-	-
Glass decorative cover	-	-	-	-

8519	8518	8521	8522	8523
8435025785199	8435025785182	8435025785212	8435025785229	8435025785236
MISTRAL 90 SW	SLIM 90 CU	FRIDA 90 CU	FRIDA 80 CU	DEIMOS 1000 RD
inclined wall mounted	Wall chimney	inclined wall mounted	inclined wall mounted	Ceiling
18,3	21,3	14,5	14,5	24,9
A+++	A++	A+++	A+++	A+
40,3	39,3	39,7	39,7	39,3
A	A	A	A	A
14,8	14,8	26,3	26,3	11,5
D	D	B	B	E
60,2	58,6	75,5	75,5	58,6
E	E	C	C	E
282,8	270,8	200	200	270,8
640,5	608,5	605	605	608,5
841,6	851,6	825	825	851,6
46	46	40	40	46
64	65	64	64	65
69	70	69	69	70
0,46	0,46	0,4	0,4	0,46
-	-	0	0	-
0,5	0,6	0,6	0,6	0,6
29,5	34,2	29,3	29,3	38,2
369,6	369,4	259,7	259,7	369,4
314	308	326,2	326,2	308
80	80,5	59,2	59,2	80,5
5	5	3	3	10
74	74	79	79	115
895	900	900	800	1000
446	480	370	370	600
1175	1030	1170	1170	500
860	632	855	855	285
150	150	150/125	150/125	150
BT4DC	BT4DC	BT4DC	BT4DC	BT4DC
5+1	5+1	5+1	5+1	5+1
135	135	135	135	135
357	357	357	357	357
365	365	365	365	365
TCD6i	TCD6i	TCMD6i	TCMD6i	TCD6i + Remote Control
√	√	√	√	√
√	√	√	√	√
Aluminum metallic	Premium Decorative s. steel	Aluminum metallic	Aluminum metallic	Aluminum metallic
3	3	2+1	2+1	3
-	√	-	-	-
SSLED	SSLED	SSLED	SSLED	SSLED
√	√	√	√	√
1	1	1	1	2
400	650	400	400	550
650	650	650	650	700
√ / √	√ / √	√ / √	√ / √	√ / √
√	√	√	√	√
140	140	143	143	145
220-240	220-240	220-240	220-240	220-240
50/60	50/60	50	50	50/60
CLASS I	CLASS I	CLASS I	CLASS I	CLASS I
-	-	-	-	-
-	-	-	-	-
02832008	02832008	02832008	02832008	√
-	-	-	-	-
2811002	02800204	02800905* / 02800925*	02800905* / 02800925*	02800200
-	02800922	02800918 / 02800927	02800918 / 02800927	02800918
02859318	02859318	02859318	02859398	02859399
02893002	02893002	02893002	02893002	02893002
-	-	-	-	-
-	-	-	-	-
-	-	-	-	-

Code	1756	4140	4141	4142
EAN	8435025717565	8422248104883	8422248104890	8422248104906
Model	SPIRIT RR	IS N9420 BK	IS N8420 BK	IS N6420 BK
Type	Pyramid	Surface	Surface	Surface
Product fiche according to directives EU65/2014 - EN61591, EN60704-2-13, EN50564				
AEC (Annual Energy consumption) (kWh/annum)	60,4	25,5	23,5	51,7
EEL class (Energy Efficiency Class)	B	A+	A+	A+
FDE (Fluid Dynamic Efficiency)	21,9	42,5	29,9	24,8
FDE class (Fluid Dynamic Efficiency Class)	C	A	A	A
LE (Lighting Efficiency) (lux/W)	36	-	-	-
LE class (Lighting Efficiency Class)	A	-	-	-
GFE (Grease Filtering Efficiency)	77,1	98,2	97,6	95,1
GFE Class (Grease Filtering Efficiency class)	C	A	A	A
Air flow at minimum speed (m3/h)	341,3	117,3	96,6	110
Air flow at maximum speed (m3/h)	600	479	435	491
Air flow at intensive speed (TURBO) (m3/h)	-	605	570	566
Sound Power Level at minimum speed (dB)	58	33	35	30
Sound Power Level at maximum speed (dB)	70	62	70	66
Sound Power Level at intensive speed (TURBO) (dB)	-	65	74	71,3
Po (Power Consumption in off mode) (W)	0	0,5	0,5	0,5
Ps (Power Consumption in standby) (W)	-	-	-	-
Integration directive EU 66/2014				
f (Time Increase Factor)	1,2	0,47	0,92	1,11
EEL (Energy Efficiency Index)	66,8	28,6	43	60
QBEP (Flow Rate at Best Efficiency Point) (m3/h)	311,8	497	239	291
PBEP (Static Pressure Difference at Best Efficiency Point) (Pa)	340	541	322	397
WBEP (Electric Power Input at Best Efficiency Point) (W)	134,6	176	162	129
WL (Nominal Power Consumption of Lighting system) (W)	2	-	-	-
EMIDDLE (Average Illumination of Lighting system on Cooking surface) (lux)	72	-	-	-
External Dimensions				
Width (mm)	900	900	800	600
Depth (mm)	500	520	520	520
Total max height(mm)	1040	212	212	212
Total min height(mm)	660	208	208	208
Outlet Diameter (mm)	150	150	150	150
Characteristics				
Motor	BTAT6	EBM EC	EBM EC	EBM EC
Extraction Levels	3	9+1	9+1	9+1
Motor Maximum Power Consumption	190	168	168	168
Maximum Pressure	457,8	920	1010	660
Intensive Speed (TURBO) Pressure	-	1133	1249	660
Control Type	Mechanical	Touch Slider	Touch Slider	Touch Slider
Automatic shut-down timer	-	Yes	Yes	Yes
Electronic Filter Saturation Indicator	-	Yes	Yes	Yes
Filter Type	Aluminum metallic	Aluminium mettalic	Aluminium mettalic	Aluminium mettalic
Anti-grease Filter Number	3	4	4	4
Inner Shield	-	-	-	-
Lighting				
Light Type	CSLED	-	-	-
Adjustable Intensity Lighting	-	-	-	-
Nº of Lamps	1	-	-	-
Installation				
Minimum height distance to a electric worktop hob (mm)	550	-	-	-
Minimum height distance to a gas worktop hob (mm)	650	-	-	-
Instalation with Outlet tube to the exterior / Recirculating	√ / √	-	-	-
Easy Instalation System	√	-	-	-
Electric Connection				
Total Rush Power (W)	192	168	168	168
Rated Voltage (V)	220-240	220-240	220-240	220-240
Network Frequency (Hz)	50	50/60	50/60	50/60
Electrical Insulation Class	Class I	CLASS I	CLASS I	CLASS I
Plug	-	No	No	No
Accessories				
Upper Decorative tube Extension	-	-	-	-
Island Tube Enhancer	-	-	-	-
Check Valve	√	-	-	-
MAX PRO Metal Filter	-	-	-	-
Metal Filter	02800956	02808306	02808301	02808310
DUAL Filter (metal + active charcoal)	-	-	-	-
Active Charcoal Filter	02800959	02808308	02808305	02808309
Noiseless Flexible Duct	02839002	-	-	-
Reirculation kit (Piping kit + active charcoal filters)	-	02808307	02808302	02808302
Aluminium decorative cover	-	-	02808303	02808311
Glass decorative cover	-	-	02808304	02808312

8525	8526	8527	8545	8546	8393	8547
8435025785250	8435025785267	8435025785274	8435025785458	8435025785465	8435025783935	8435025785472
ISLA DEIMOS 1400 TWIN RF	ISLA DEIMOS X 1200 RF	ISLA DEIMOS 1000 RF	ISLA CUBE GLASS ECO 60 BK	ISLA CUBE GLASS ECO 60 WH	ISLA SLIMOS 900	ISLA MIRAGE PREMIUM 120
Ceiling	Ceiling	Ceiling	Horizontal island	Horizontal island	Ceiling	Horizontal island
44	26,9	26,9	30	30	30	26
A+	A+	A+	A	A	A	A+
39,3	37,5	37,5	34,7	34,7	34,7	33,1
A	A	A	A	A	A	A
16,7	34	34	36,6	36,6	36,6	36
D	B	B	A	A	A	A
58,6	62,7	62,7	91,2	91,2	91,2	91,2
E	E	E	B	B	B	B
400	245	245	200	200	200	200
645	509,4	509,4	645	645	565	645
1100 / 1600	765,3	765,3	820	820	750	820
47	46	46	42	42	42	40
66	63	63	66	66	66	64
75 / 77	67	67	69	69	69	67
0,46	0,46	0,46	0,41	0,41	0,41	0,41
-	-	-	-	-	-	-
0,6	0,7	0,7	0,8	0,8	0,8	0,8
39,8	42,8	42,8	47,9	47,9	47,9	44,8
738,8	346,6	346,6	363,7	363,7	363,7	344,8
308	298	298	248	248	248	244
161	76,6	76,6	74,8	74,8	74,8	70,8
12	10	10	14	14	14	7
200	340	340	513	513	513	252
1400	1200	1000	620	620	900	1200
700	600	600	480	480	500	810
500	500	500	1140	1140	-	1040
285	285	285	815	815	155	790
2 x 150	150	150	150/125	150/125	180 x 90/Ø150	150/125
BT4DC	BT4DC	BT4DC	BTDCA	BTDCA	BTDCA	BTDCA
4+1+1	5+1	5+1	4 + 1	4 + 1	4 + 1	4 + 1
2 x 135	135	135	130	130	130	130
310	357	357	455	455	455	455
357 / 365	365	365	470	470	470	470
TCD6i + Remote Control	TCD6i + Remote Control	TCD6i + Remote Control	TCSi	TCSi	TCSi	TCSi
√	√	√	√	√	√	√
√	√	√	√	√	√	√
Aluminum metallic	Aluminum metallic	Aluminum metallic	Premium Decorative S. steel	Premium Decorative S. steel	Aluminum metallic	Premium Decorative S. steel
4	3	3	2	2	2	8
-	-	-	-	-	-	√
SSLED	SSLED	SSLED	ECOLED	ECOLED	Eco Led Strip	Eco Led Strip
√	√	√	√	√	√	√
4	2	2	4	4	4	2
550	550	550	650	650	550	650
700	700	700	650	650	700	650
√ / √	√ / √	√ / √	√ / √	√ / √	√ / √	√ / √
√	√	√	√	√	√	√
282	145	145	144	144	142	137
220-240	220-240	220-240	220-240	220-240	220-240	220-240
50/60	50/60	50/60	50	50	50	50
CLASS I	CLASS I	CLASS I	CLASS II	CLASS II	CLASS II	CLASS II
-	-	-	-	-	EU	EU
-	-	-	-	-	-	-
√	√	√	02832004	02832004	-	02864300
-	-	-	02800917	02800917	-	02832004
02800920	02800200	02800200	02800210	02800210	02800920	02800917
02800922	02800918	02800918	02800918	02800918	02800922	02800210
02859399	02859399	02859399	02859392	02859392	-	02800918
2 x 02893002	02893002	02893002	02893002	02893002	-	02859392
-	-	-	-	-	-	02893002
-	-	-	-	-	-	-
-	-	-	-	-	-	-

Code	8548	8375	8528
EAN	8435025785489	8435025783751	8435025785281
Model	ISLA MIRAGE PREMIUM 90	ISLA SOL X /B	CUBE GLASS ECO 70 BK
Type	Horizontal island	Island	Wall chimney
Product fiche according to directives EU65/2014 - EN61591, EN60704-2-13, EN50564			
AEC (Anual Energy consumption) (kWh/annum)	23,5	97,1	53,6
EEL class (Energy Efficiency Class)	A+	C	A
FDE (Fluid Dynamic Efficiency)	33,1	15,9	30,6
FDE class (Fluid Dynamic Efficiency Class)	A	D	A
LE (Lighting Efficiency) (lux/W)	41,2	14,3	41,2
LE class (Lighting Efficiency Class)	A	D	A
GFE (Grease Filtering Efficiency)	91,2	91,2	91,2
GFE Class (Grease Filtering Efficiency class)	B	B	B
Air flow at minimum speed (m3/h)	200	300	340
Air flow at maximum speed (m3/h)	645	645	600
Air flow at intensive speed (TURBO) (m3/h)	820	790	820
Sound Power Level at minimum speed (dB)	40	48	50
Sound Power Level at maximum speed (dB)	64	63	65
Sound Power Level at intensive speed (TURBO) (dB)	67	65	67
Po (Power Consumption in off mode) (W)	0,41	0,26	0,32
Ps (Power Consumption in standby) (W)	-	-	-
Integration directive EU 66/2014			
f (Time Increase Factor)	0,8	1,4	0,9
EEL (Energy Efficiency Index)	41,8	84,1	52,1
QBEP (Flow Rate at Best Efficiency Point) (m3/h)	344,8	386,4	416,9
PBEP (Static Pressure Difference at Best Efficiency Point) (Pa)	244	254	411
WBEP (Electric Power Input at Best Efficiency Point) (W)	70,8	171,5	155,7
WL (Nominal Power Consumption of Lighting system) (W)	3,5	10,5	3,5
EMIDDLE (Average Illumination of Lighting system on Cooking surface) (lux)	144,2	150	144,2
External Dimensions			
Width (mm)	900	400	700
Depth (mm)	610	400	420
Total max height(mm)	1040	700	1000
Total min height(mm)	790	1090	650
Outlet Diameter (mm)	150/125	150/125	150/125
Characteristics			
Motor	BTDCA	BT2	BT3
Extraction Levels	4 + 1	2 + 1	3 + 1
Motor Maximum Power Consumption	130	240	280
Maximum Pressure	455	400	450
Intensive Speed (TURBO) Pressure	470	405	470
Control Type	TCSi	VL3i	TC4i
Automatic shut-down timer	√	√	√
Electronic Filter Saturation Indicator	√	-	√
Filter Type	Premium Decorative S. steel	Aluminum metallic	Decorative stainless steel
Anti-grease Filter Number	4	1	2
Inner Shield	√	-	-
Lighting			
Light Type	Eco Led Strip	ECOLED	Eco Led Strip
Adjustable Intensity Lighting	√	-	√
Nº of Lamps	1	3	1
Installation			
Minimum height distance to a electric worktop hob (mm)	650	650	650
Minimum height distance to a gas worktop hob (mm)	650	650	650
Instalation with Outlet tube to the exterior / Recirculating	√ / √	√ / √	√ / √
Easy Instalation System	√	√	√
Electric Connection			
Total Rush Power (W)	133,5	250,5	285
Rated Voltage (V)	220-240	220-240	220-240
Network Frequency (Hz)	50	50	50
Electrical Insulation Class	CLASS II	CLASS II	CLASS II
Plug	-	EU	EU
Accessories			
Upper Decorative tube Extension	-	-	-
Island Tube Enhancer	02864300	-	-
Check Valve	02832004	02832004	02832004
MAX PRO Metal Filter	02800917	-	02800917
Metal Filter	02800210	02800915	02800206
DUAL Filter (metal + active charcoal)	02800918	02800921	02800918
Active Charcoal Filter	02859392	-	02859392
Noiseless Flexible Duct	02893002	02893002	02893002
Recirculation kit (Piping kit + active charcoal filters)	-	-	-
Aluminium decorative cover	-	-	-
Glass decorative cover	-	-	-

8529	8532	8533	8549	8536	8537	8520
8435025785298	8435025785328	8435025785335	8435025785496	8435025785366	8435025785373	8435025785205
CUBE GLASS ECO 70 WH	CUBE GLASS ECO 90 BK	CUBE GLASS ECO 90 WH	SLIM 110 BK	SLIM 90 BK	SLIM 90 WH	SLIM 70 BK
Wall chimney	Wall chimney	Wall chimney	Wall chimney	Wall chimney	Wall chimney	Wall chimney
53,6	53,6	53,6	21,3	21,3	21,3	19,8
A	A	A	A++	A++	A++	A++
30,6	30,6	30,6	39,3	39,3	39,3	39,3
A	A	A	A	A	A	A
41,2	41,2	41,2	14,8	14,8	14,8	22,3
A	A	A	D	D	D	B
91,2	91,2	91,2	58,6	58,6	58,6	58,6
B	B	B	E	E	E	E
340	340	340	270,8	270,8	270,8	270,8
600	600	600	608,5	608,5	608,5	608,5
820	820	820	851,6	851,6	851,6	851,6
50	50	50	46	46	46	46
65	65	65	65	65	65	65
67	67	67	70	70	70	70
0,32	0,32	0,32	0,46	0,46	0,46	0,46
-	-	-	-	-	-	-
0,9	0,9	0,9	0,6	0,6	0,6	0,6
52,1	52,1	52,1	34,2	34,2	34,2	32,4
416,9	416,9	416,9	369,4	369,4	369,4	369,4
411	411	411	308	308	308	308
155,7	155,7	155,7	80,5	80,5	80,5	80,5
3,5	3,5	3,5	5	5	5	3
144,2	144,2	144,2	74	74	74	67
700	900	900	1100	900	900	700
420	420	420	480	480	480	480
1000	1000	1000	1030	1030	1030	1030
650	650	650	632	632	632	632
150/125	150/125	150/125	150	150	150	150
BT3	BT3	BT3	BT4DC	BT4DC	BT4DC	BT4DC
3 + 1	3 + 1	3 + 1	5+1	5+1	5+1	5+1
280	280	280	135	135	135	135
450	450	450	357	357	357	357
470	470	470	365	365	365	365
TC4i	TC4i	TC4i	TCD6i	TCD6i	TCD6i	TCD6i
√	√	√	√	√	√	√
√	√	√	√	√	√	√
Decorative s.steel	Decorative s.steel	Decorative s.steel	Premium DecorativeS.steel	Premium DecorativeS.steel	Premium DecorativeS.steel	Premium DecorativeS.steel
2	3	3	4	3	3	2
-	-	-	√	√	√	√
Eco Led Strip	Eco Led Strip	Eco Led Strip	SSLED	SSLED	SSLED	SSLED
√	√	√	√	√	√	√
1	1	1	1	1	1	1
650	650	650	650	650	650	650
650	650	650	650	650	650	650
√ / √	√ / √	√ / √	√ / √	√ / √	√ / √	√ / √
√	√	√	√	√	√	√
285	285	285	140	140	140	138
220-240	220-240	220-240	220-240	220-240	220-240	220-240
50	50	50	50/60	50/60	50/60	50/60
CLASS II	CLASS II	CLASS II	CLASS I	CLASS I	CLASS I	CLASS I
EU	EU	EU	-	-	-	-
-	-	-	02861300	02861300	02861300	02861300
-	-	-	-	-	-	-
02832004	02832004	02832004	02832008	02832008	02832008	02832008
02800917	02800917	02800917	-	-	-	-
02800206	02800206	02800206	02800205	02800204	02800204	02800204
02800918	02800918	02800918	-	02800922	02800922	02800922
02859392	02859392	02859392	02859399	02859399	02859399	02859399
02893002	02893002	02893002	02893002	02893002	02893002	02893002
-	-	-	-	-	-	-
-	-	-	-	-	-	-
-	-	-	-	-	-	-

Code	8563	8556	8557	8559
EAN	8435025785632	8435025785564	8435025785571	8435025785595
Model	SLIM 70 WH	LICEO 90 INOX /D	LICEO 70 INOX /D	SCALA 90 INOX /B
Type	Wall chimney	Wall chimney	Wall chimney	Pyramid
Product fiche according to directives EU65/2014 - EN61591, EN60704-2-13, EN50564				
AEC (Annual Energy consumption) (kWh/annum)	19,8	56,3	56,3	56,3
EEL class (Energy Efficiency Class)	A++	A	A	A
FDE (Fluid Dynamic Efficiency)	39,3	30,6	30,6	30,6
FDE class (Fluid Dynamic Efficiency Class)	A	A	A	A
LE (Lighting Efficiency) (lux/W)	22,3	36	36	33,7
LE class (Lighting Efficiency Class)	B	A	A	A
GFE (Grease Filtering Efficiency)	58,6	91,2	91,2	91,2
GFE Class (Grease Filtering Efficiency class)	E	B	B	B
Air flow at minimum speed (m3/h)	270,8	340	340	340
Air flow at maximum speed (m3/h)	608,5	600	600	650
Air flow at intensive speed (TURBO) (m3/h)	851,6	850	850	900
Sound Power Level at minimum speed (dB)	46	50	50	52
Sound Power Level at maximum speed (dB)	65	65	65	67
Sound Power Level at intensive speed (TURBO) (dB)	70	67	67	69
Po (Power Consumption in off mode) (W)	0,46	0,33	0,33	0,33
Ps (Power Consumption in standby) (W)	-	-	-	-
Integration directive EU 66/2014				
f (Time Increase Factor)	0,6	0,9	0,9	0,9
EEL (Energy Efficiency Index)	32,4	53,7	53,7	53,7
QBEP (Flow Rate at Best Efficiency Point) (m3/h)	369,4	416,9	416,9	416,9
PBEP (Static Pressure Difference at Best Efficiency Point) (Pa)	308	411	411	411
WBEP (Electric Power Input at Best Efficiency Point) (W)	80,5	155,7	155,7	155,7
WL (Nominal Power Consumption of Lighting system) (W)	3	7	7	7
EMIDDLE (Average Illumination of Lighting system on Cooking surface) (lux)	67	252	252	252
External Dimensions				
Width (mm)	700	900	700	900
Depth (mm)	480	500	500	500
Total max height(mm)	1030	1035	1035	1040
Total min height(mm)	632	635	635	740
Outlet Diameter (mm)	150	150 / 125	150 / 125	150 / 125
Characteristics				
Motor	BT4DC	BT3	BT3	BT3
Extraction Levels	5+1	3+1	3+1	3+1
Motor Maximum Power Consumption	135	280	280	280
Maximum Pressure	357	450	450	450
Intensive Speed (TURBO) Pressure	365	470	470	470
Control Type	TCD6i	NL4i	NL4i	NL4i
Automatic shut-down timer	√	√	√	√
Electronic Filter Saturation Indicator	√	√	√	√
Filter Type	Premium Decorative S.steel	Decorative s.steel	Decorative s.steel	Decorative s.steel
Anti-grease Filter Number	2	3	2	3
Inner Shield	√	-	-	-
Lighting				
Light Type	SSLED	ECOLED	ECOLED	ECOLED
Adjustable Intensity Lighting	√	√	√	√
Nº of Lamps	1	2	2	2
Installation				
Minimum height distance to a electric worktop hob (mm)	650	650	650	650
Minimum height distance to a gas worktop hob (mm)	650	650	650	650
Instalation with Outlet tube to the exterior / Recirculating	√ / √	√ / √	√ / √	√ / √
Easy Instalation System	√	√	√	√
Electric Connection				
Total Rush Power (W)	138	287	287	287
Rated Voltage (V)	220-240	220-240	220-240	220-240
Network Frequency (Hz)	50/60	50	50	50
Electrical Insulation Class	CLASS I	CLASS II	CLASS II	CLASS II
Plug	-	EU	EU	EU
Accessories				
Upper Decorative tube Extension	02861300	02861300	02861300	02861300
Island Tube Enhancer	-	-	-	-
Check Valve	02832008	02832004	02832004	02832004
MAX PRO Metal Filter	-	02800917	02800917	02800917
Metal Filter	02800204	02800206	02800206	02800206
DUAL Filter (metal + active charcoal)	02800922	02800918	02800918	02800918
Active Charcoal Filter	02859399	02859392	02859392	02859392
Noiseless Flexible Duct	02893002	02893002	02893002	02893002
Reirculation kit (Piping kit + active charcoal filters)	-	-	-	-
Aluminium decorative cover	-	-	-	-
Glass decorative cover	-	-	-	-

8561	8562	8369	8370	8540	8550	8551
8435025785618	8435025785625	8435025783690	8435025783706	8435025785403	8435025785502	8435025785519
SCALA 70 INOX /B	SCALA 60 INOX /B	GALA L /B	GALA R /B	GREGAL 90 WH NMOTION	GREGAL 60 WH NMOTION	ECLIPSE 90 BK
Pyramid	Pyramid	Corner wall chimney	Corner wall chimney	Integrated	Integrated	Canopy
56,3	56,3	53,6	53,6	24,7	21,8	56,1
A	A	A	A	A+	A++	A
30,6	30,6	30,6	30,6	37,5	37,5	30,2
A	A	A	A	A	A	A
33,7	33,7	41,2	41,2	23,7	22,3	26
A	A	A	A	B	B	B
91,2	91,2	91,2	91,2	62,7	62,7	91,2
B	B	B	B	E	E	B
340	340	340	340	245	245	340
650	650	600	600	536,6	536,6	600
900	900	820	820	765,3	765,3	750
52	52	50	50	46	46	50
67	67	65	65	63	63	65
69	69	67	67	67	67	67
0,33	0,33	0,32	0,32	0,49	0,49	0,3
-	-	-	-	-	-	-
0,9	0,9	0,9	0,9	0,7	0,7	0,9
53,7	53,7	52,1	52,1	40,3	36,9	53
416,9	416,9	416,9	416,9	346,6	346,6	429,4
411	411	411	411	298	298	405
155,7	155,7	155,7	155,7	76,6	76,6	159,8
7	7	3,5	3,5	7	3	5
252	252	144,2	144,2	166	67	130
700	700	900	900	900	600	830
500	500	500	500	310-350	310-350	280
1040	1040	985	985	332	332	316
740	740	635	635	332	332	316
150 / 125	150 / 125	150/125	150/125	150	150	150
BT3	BT3	BT3	BT3	BT4DC	BT4DC	BT3
3+1	3+1	3+1	3+1	5+1	5+1	3+1
280	280	280	280	135	135	280
450	450	450	450	357	357	450
470	470	470	470	365	365	470
NL4i	NL4i	NL4i	NL4i	TCMD6i	TCMD6i	TC4i
√	√	√	√	√	√	√
√	√	√	√	√	√	√
Decorative s. steel	Decorative s. steel	Decorative s. steel	Decorative s. steel	Aluminum metallic	Aluminum metallic	Aluminum metallic
2	2	3	3	3	2	3
-	-	-	-	-	-	-
ECOLED	ECOLED	Eco Led Strip	Eco Led Strip	SSLED	SSLED	SSLED
√	√	√	√	√	√	√
2	2	1	1	1	1	1
650	650	650	650	550	550	550
650	650	650	650	650	650	650
√ / √	√ / √	√ / √	√ / √	√ / √	√ / √	√ / √
√	√	√	√	√	√	√
287	287	285	285	146	144	285
220-240	220-240	220-240	220-240	220-240	220-240	220-240
50	50	50	50	50/60	50/60	50
CLASS II	CLASS II	CLASS II	CLASS II	CLASS I	CLASS I	CLASS II
EU	EU	EU	EU	-	-	EU
02861300	02861300	-	-	-	-	-
-	-	-	-	-	-	-
02832004	02832004	02832004	02832004	02832008	02832008	02832004
02800917	02800917	02800917	02800917	-	-	-
02800206	02800206	02800206	02800206	02811000	02811000	02800955
02800918	02800918	02800918	02800918	2811003	02811003	-
02859392	02859392	02859392	02859392	02859399	02859399	02859398
02893002	02893002	02893002	02893002	02893002	02893002	02893002
-	-	-	-	-	-	-
-	-	-	-	-	-	-
-	-	-	-	-	-	-

Code	8552	1709	1715	1716
EAN	8435025785526	8435025717091	8435025717152	8435025717170
Model	ECLIPSE 60 BK	EXTENDER PLUS 90 X /A	EXTENDER PLUS 70 X /A	EXTENDER PLUS 60 X /A
Type	Canopy	Telescopic	Telescopic	Telescopic
Product fiche according to directives EU65/2014 - EN61591, EN60704-2-13, EN50564				
AEC (Annual Energy consumption) (kWh/annum)	55	97,7	97,7	97,7
EEL class (Energy Efficiency Class)	A	C	C	C
FDE (Fluid Dynamic Efficiency)	30,2	16,2	16,2	16,2
FDE class (Fluid Dynamic Efficiency Class)	A	D	D	D
LE (Lighting Efficiency) (lux/W)	31	36	36	37
LE class (Lighting Efficiency Class)	A	A	A	A
GFE (Grease Filtering Efficiency)	91,2	91,2	91,2	91,2
GFE Class (Grease Filtering Efficiency class)	B	B	B	B
Air flow at minimum speed (m3/h)	340	300	300	300
Air flow at maximum speed (m3/h)	600	645	645	645
Air flow at intensive speed (TURBO) (m3/h)	750	-	-	-
Sound Power Level at minimum speed (dB)	50	50	50	50
Sound Power Level at maximum speed (dB)	65	67	67	67
Sound Power Level at intensive speed (TURBO) (dB)	67	-	-	-
Po (Power Consumption in off mode) (W)	0,3	-	-	-
Ps (Power Consumption in standby) (W)	-	-	-	-
Integration directive EU 66/2014				
f (Time Increase Factor)	0,9	1,4	1,4	1,4
EEL (Energy Efficiency Index)	53	83,1	83,1	83,1
QBEP (Flow Rate at Best Efficiency Point) (m3/h)	429,4	374,2	374,2	374,2
PBEP (Static Pressure Difference at Best Efficiency Point) (Pa)	405	278	278	278
WBEP (Electric Power Input at Best Efficiency Point) (W)	159,8	178,9	178,9	178,9
WL (Nominal Power Consumption of Lighting system) (W)	3,5	7	7	7
EMIDDLE (Average Illumination of Lighting system on Cooking surface) (lux)	109	252	252	252
External Dimensions				
Width (mm)	530	900	700	600
Depth (mm)	280	460	460	460
Total max height(mm)	316	271	271	
Total min height(mm)	316	271	271	
Outlet Diameter (mm)	150	150	150	150
Characteristics				
Motor	BT3	SILENTECH	SILENTECH	SILENTECH
Extraction Levels	3+1	2	2	2
Motor Maximum Power Consumption	280	240	240	240
Maximum Pressure	450	405	405	405
Intensive Speed (TURBO) Pressure	470	-	-	-
Control Type	TC4i	Rocker Switch	Rocker Switch	Rocker Switch
Automatic shut-down timer	√	-	-	-
Electronic Filter Saturation Indicator	√	-	-	-
Filter Type	Aluminum metallic	Decorative s. steel	Decorative s. steel	Decorative s. steel
Anti-grease Filter Number	2	2	2	2
Inner Shield	-	√	√	√
Lighting				
Light Type	SSLED	ECOLED	ECOLED	ECOLED
Adjustable Intensity Lighting	√	-	-	-
Nº of Lamps	1	2	2	2
Installation				
Minimum height distance to a electric worktop hob (mm)	550	550	550	551
Minimum height distance to a gas worktop hob (mm)	650	650	650	651
Instalation with Outlet tube to the exterior / Recirculating	√ / √	√ / √	√ / √	√ / √
Easy Instalation System	√	√	√	√
Electric Connection				
Total Rush Power (W)	283,5	247	247	247
Rated Voltage (V)	220-240	220-240	220-240	220-240
Network Frequency (Hz)	50	50	50	50
Electrical Insulation Class	CLASS II	CLASS II	CLASS II	CLASS II
Plug	EU	EU	EU	EU
Accessories				
Upper Decorative tube Extension	-	-	-	-
Island Tube Enhancer	-	-	-	-
Check Valve	02832004	02832004	02832004	02832004
MAX PRO Metal Filter	-	-	-	-
Metal Filter	02800955	02825278	02825277	02825276
DUAL Filter (metal + active charcoal)	-	-	-	-
Active Charcoal Filter	02859398	02825263	02825263	02825263
Noiseless Flexible Duct	02893002	02893002	02893002	02893002
Recirculation kit (Piping kit + active charcoal filters)	-	-	-	-
Aluminium decorative cover	-	-	-	-
Glass decorative cover	-	-	-	-

1698	1699	1700	1733	1732
8435025716988	8435025716995	8435025717008	8435025717336	8435025717336
EXTENDER 900	EXTENDER 700	EXTENDER 600	EXTENDER 600 BK	EXTENDER 600 WH
Telescopic	Telescopic	Telescopic	Telescopic	Telescopic
46,3	44,5	44,5	44,5	44,5
C	C	C	C	C
10,1	11,9	11,9	11,9	11,9
E	E	E	E	E
38	39	40	41	42
A	A	A	A	A
68	68	68	68	68
D	D	D	D	D
150	150	150	150	150
390	390	390	390	390
-	-	-	-	-
45,5	45,5	45,5	45,5	45,5
57	57	57	57	57
-	-	-	-	-
-	-	-	-	-
-	-	-	-	-
1,6	1,6	1,6	1,6	1,6
81,1	78,2	78,2	78,2	78,2
201,1	201,1	201,1	201,1	201,1
125	125	125	125	125
69	69	69	69	69
7	7	7	7	7
252	252	252	252	252
900	700	600	600	600
440	440	440	440	440
120	120	120	120	120
TF 2003	TF 2003	TF 2003	TF 2003	TF 2003
2	2	2	2	2
100	100	100	100	100
194	194	194	194	194
-	-	-	-	-
Rocker Switch	Rocker Switch	Rocker Switch	Rocker Switch	Rocker Switch
-	-	-	-	-
-	-	-	-	-
Decorative s. steel	Decorative s. steel	Decorative s. steel	Decorative s. steel	Decorative s. steel
2	2	2	2	2
√	√	√	√	√
ECOLED	ECOLED	ECOLED	ECOLED	ECOLED
-	-	-	-	-
2	2	2	2	2
552	553	554	555	556
652	653	654	655	656
√ / √	√ / √	√ / √	√ / √	√ / √
√	√	√	√	√
107	107	107	107	107
220-240	220-240	220-240	220-240	220-240
50	50	50	50	50
CLASS I	CLASS I	CLASS I	CLASS I	CLASS I
-	-	-	-	-
-	-	-	-	-
02849003	02849004	02849005	02849006	02849007
02825278	02825279	02825280	02825281	02825282
-	-	-	-	-
02825263	02825264	02825265	02825266	02825267
02800000	02800001	02800002	02800003	02800004
-	-	-	-	-
-	-	-	-	-
-	-	-	-	-

Code	4103	4104	4107	4126
EAN	8435025741034	8435025741041	8435025741072	8435025741263
Model	IH N9205 BK	IH N8205 BK	IH N6404 BK	IH N7003 BK
Type	Induction	Induction	Induction	Induction
Product fiche				
Cooking zones	Total cooking surface	Total cooking surface	4	3
Right front zone: Diameter (mm)	-	-	215x200	220
Right front zone: Power (kW)	-	-	2,1	2,3
Right front zone: Booster (kW)	-	-	3	3
Right front zone: Consumption (Wh/kg)	-	-	189	183
Right rear zone: Diameter (mm)	-	-	215x200	-
Right rear zone: Power (kW)	-	-	2,1	-
Right rear zone: Booster (kW)	-	-	3	-
Right rear zone: Consumption (Wh/kg)	-	-	189	-
Central front zone: Diameter (mm)	-	-	-	-
Central front zone: Power (kW)	-	-	-	-
Central front zone: Booster (kW)	-	-	-	-
Central front zone: Consumption (Wh/kg)	-	-	-	-
Central rear zone: Diameter (mm)	-	-	-	180
Central rear zone: Power (kW)	-	-	-	1,4
Central rear zone: Booster (kW)	-	-	-	-
Central rear zone: Consumption (Wh/kg)	-	-	-	181
Front left zone: Diameter (mm)	-	-	215x200	180
Front left zone: Power (kW)	-	-	2,1	1,4
Front left zone: Booster (kW)	-	-	3	-
Front left zone: Consumption (Wh/kg)	-	-	189	181
Left rear zone: Diameter (mm)	-	-	215x200	-
Left rear zone: Power (kW)	-	-	2,1	-
Left rear zone: Booster (kW)	-	-	3	-
Left rear zone: Consumption (Wh/kg)	-	-	189	-
Energy consumption of the hob (Wh/kg)	190,7	191	189	181,7
Dimensions				
Product width (mm)	930	810	590	700
Product depth (mm)	520	520	520	350
Product height (mm)	55	55	55	74
Built-in height (mm)	908	795	565	680
Built-in depth (mm)	503	503	495	330
Ventilation slot (mm)	5	5	5	5
Fixing system	Quick-Fix System	Quick-Fix System	Quick-Fix System	Quick-Fix System
Finishing				
Colour	Black	Black	Black	Black
Aesthetic	Front bevel	Front bevel	Front bevel	Front bevel
Control				
Control type	Hidden Multi Slider Touch	Hidden Multi Slider Touch	Hidden Mono Slider Touch	Mono Slider Touch
Power selection (+/-)	Individual per zone	Individual per zone	Centralized	Centralized
Power levels	17 + 2xBooster	17 + 2xBooster	9 + Booster	9 + Booster
Timer	Yes	Yes	Yes	Yes
Countdown alarm	Yes	Yes	Yes	Yes
Power limit function	Yes	Yes	No	No
Security				
Safety lock	Yes	Yes	Yes	Yes
Residual heat indicator	Yes	Yes	Yes	Yes
Automatic pan detection	Yes	Yes	Yes	Yes
Automatic safety switch-off	Yes	Yes	Yes	Yes
Protection against liquid spillage	Yes	Yes	Yes	Yes
Electrical connection				
Nominal voltage (V)	220-240	220-240	220-240	220-240
Mains frequency (Hz)	50-60	50-60	50-60	50/60
Max Product power (kW)	11	11	7,4	5,8

4111	4112	4113	4110	4114	4115	4117
8435025741119	8435025741126	8435025741133	8435025741102	8435025741140	8435025741157	8435025741171
IH N7703 BK	IH N7502 BK	IH N5902 BK	IH N3200 BK	IV N7502 BK	IV N7503 BK	VH N7502
Induction	Induction	Induction	Induction	Induction+Radiant	Induction+Radiant	Radiant
3	2	2	2	2	3	2
-	-	-	210x200	-	220	-
-	-	-	1,6	-	2,3	-
-	-	-	1,85	-	3	-
-	-	-	182,9	-	176,3	-
270	220	180	210x200	220	-	180
2,3	2,3	1,4	2,1	2,3	-	1,8
3	3	-	3	3	-	-
187,2	176,3	184,9	182,7	176,3	-	146,2
-	-	-	-	-	-	-
-	-	-	-	-	-	-
-	-	-	-	-	-	-
180	-	-	-	-	180	-
1,4	-	-	-	-	1,4	-
-	-	-	-	-	-	-
184,9	-	-	-	-	184,9	-
220	-	-	-	-	-	-
2,3	-	-	-	-	-	-
3	-	-	-	-	-	-
176,3	-	-	-	-	-	-
-	270	220	-	270/210	270/210/145	270/210
-	2,3	2,3	-	2,4/1,5	2,7/1,95/1,05	2,4/1,5
-	3	3	-	-	-	-
-	187,2	176,3	-	193,5	140,1	193,5
182,8	182,7	180,6	182,8	184,9	167,1	169,8
770	750	590	298	750	750	750
390	450	350	520	450	450	450
68	68	68	76	68	68	67
750	710	560	275	710	710	710
370	410	330	500	410	410	410
5	5	5	5	5	5	-
Quick-Fix System	Quick-Fix System	Quick-Fix System	Quick-Fix System	Quick-Fix System	Quick-Fix System	Quick-Fix System
Black	Black	Black	Black	Black	Black	Black
Front bevel	Front bevel	Front bevel	Front bevel	Front bevel	Front bevel	Front bevel
Touch	Mono Slider Touch	Touch	Touch	Mono Slider Touch	Mono Slider Touch	Touch
Centralized	Centralized	Centralized	Centralized	Centralized	Centralized	Centralized
9 + Booster	9 + Booster	9 + Booster	9 + Booster	9 + Booster	9 + Booster	9
Yes	Yes	Yes	Yes	Yes	Yes	-
Yes	Yes	Yes	Yes	Yes	Yes	-
No	No	No	No	No	No	No
Yes	Yes	Yes	Yes	Yes	Yes	Yes
Yes	Yes	Yes	Yes	Yes	Yes	Yes
Yes	Yes	Yes	Yes	Yes	Yes	-
Yes	Yes	Yes	Yes	Yes	Yes	Yes
Yes	Yes	Yes	Yes	Yes	Yes	Yes
220-240	220-240	220-240	220-240	220-240	220-240	220-240
50/60	50/60	50/60	50/60	50/60	50/60	50/60
6,7	6	3,7	3,7	5,4	6,4	4,2

Code	4122	4123	4124	4125
EAN	8435025741225	8435025741232	8435025741249	8435025741256
Model	GH 8630 GBK	GH 7830 GBK	GH 7820 GBK	GH 7320 GBK
Type (Glass /St.Steel /Enamelled)	Glass	Glass	Glass	Glass
Product fiche				
Suitable for City Gas	Yes	Yes	Yes	Yes
Suitable for LPG	No	No	No	No
Number of burners	3	3	2	2
Triple ring power [kW]	5	5	5	5
Fast power [kW]	-	-	-	-
Semi-fast power [kW]	-	-	-	-
Semi-fast power [kW]	-	-	-	-
Auxilliar power [kW]	1,5	1,5	-	-
Triple ring consumption [l/h]	475	475	475	475
Fast consumption [l/h]	-	-	-	-
Semi-fast 1 consumption [l/h]	-	-	-	-
Semi-fast 2 consumption [l/h]	-	-	-	-
Auxilliar consumption [l/h]	143	143	-	-
Consumption hob [l/h]	1093	1093	950	950
Energy efficiency of the burner (EE gas burner)				
Energy efficiency of the hob (EE hob)				
Dimensions				
Appliance width [mm]	860	780	780	730
Appliance depth [mm]	450	450	450	430
Appliance height [mm]	70	70	70	70
Built-in width [mm]	700	700	700	700
Built-in depth [mm]	390	390	390	390
Anchor system	clips	clips	clips	clips
Characteristics				
Plug-in autoignition	Yes	Yes	Yes	Yes
Illuminated knobs	Yes	No	No	No
Nselect flame adjustment	Yes	No	No	No
Connectivity	Yes	Yes	Yes	Yes
Enamelled Grills/Burners	No	No	No	No
Cast Iron Grills/Burners	Yes	Yes	Yes	Yes
Security				
Safety valve	Yes	Yes	Yes	Yes
Electrical Connection				
Nominal voltage (V)	220-240	220-240	220-240	220-240
Mains frequency (Hz)	50-60	50-60	50-60	50-60
Product power (kW)	11,5	11,5	10	10
Accesories				
LPG butane/natural kit conversor (included)	Yes	Yes	Yes	Yes

4121	3914	3910	4015
8435025741218	8435025739147	8435025739109	8435025740150
GH N3010 GBK	GCI 59 /A	GCI 57	GCI 316 /A
Glass	Glass	Glass	Glass
Yes	Yes	Yes	Yes
No	No	No	No
1	5	5	4
5	3,5	3,5	3,5
-	3	3	-
-	1,7	1,7	1,7
-	-	-	-
-	1	1	1
	271	271	271
	190	190	190
	179	179	179
	179	179	-
	95	95	95
	914	914	914
	55.9%(A), 57.6(R), 60(SR) 55.9%(A), 57.6(R), 60(SR) 55.9%(A), 57.6(R), 60(SR)		
	58,40%	58,40%	57,80%
300	874	684	604
520	520	520	520
	100	100	100
	845	552	552
	475	470	470
clips			
Yes	Yes	Yes	Yes
No	No	No	No
No	No	No	No
No	No	No	No
No	No	No	No
Yes	Yes	Yes	Yes
Yes	Yes	Yes	Yes
220-240	220-240	220-240	220-240
50-60	50-60	50-60	50-60
5	10,9	10,9	7,9
Yes	Yes	Yes	Yes

Code	8590	8591	8584
EAN	8422248104982	8422248104999	8435025785847
Model	HAIL 201 NF GDB	HAIL 201 NF GSW	HAIL 194 TNF RR
Finish	Black	White	Red
Product fiche according to EU Regulation 2019/2016			
Category	7	7	7
Energy efficiency class	E	E	E
Energy consumption [kWh/year]	265	265	235
Refrigerator storage volume [l]	256	256	214
Freezer storage volume **** [l]	122	122	91
Star rating	4	4	4
Frost-free fridge	Yes	Yes	Yes
Frost-free freezer	Yes	Yes	Yes
Power cut safe [h]	12	12	18
Freezing capacity [kg/24h]	8,5	8,5	4
Climate class (2)	SN-N-ST-T	SN-N-ST-T	SN-N-ST-T
Noise emissions [dBA]	40	40	40
Installation type	Freestanding	Freestanding	Freestanding
Dimensions			
Height [mm]	2018	2018	1940
Width [mm]	595	595	600
Depth [mm]	660	660	707
Opening of the door	Right	Right	Right
Reversible doors	Yes	Yes	-
Wheels	Yes	Yes	-
External / Recessed handle	Recessed handle	Recessed handle	External
Control			
Cooling type	Norfrst	Norfrst	Norfrst
Control	Electronic	Electronic	Electronic
Display	Yes	Yes	-
Electronic refrigerator temperature regulation	Yes	Yes	Nfreshzone
Electronic freezer temperature regulation	Yes	Yes	Nfreshzone
Super cooling / Super freezing function	Nchilly/Nsubzero	Nchilly/Nsubzero	Nchilly/Nsubzero
Holiday function	Nsave	Nsave	-
Winter-Summer function	-	-	-
Refrigerator equipment			
Number of door balconies	3	3	4
Number of glass shelves	3	3	3
Wine rack	Yes	Yes	1
Drawer for fruits and vegetables	Ngreenbox	Ngreenbox	Ngreenbox
Chiller for meat and fish	Nlifebox	Nlifebox	-
Metallic inner decoration	Yes	Yes	-
Number of egg tray - Egg capacity	1-8	1-8	1-7
Freezer equipment			
Number of drawers - closed drawers	3	3	3
Ice trays - Ice cube capacity	1-12	1-12	1-12
Illumination			
Fridge / Freezer lightning	Yes / -	Yes / -	Yes / -
LED lightning	Yes	Yes	Yes
Power and water connection			
Voltage range [V]	220-240	220-240	220-240
Frecuency [Hz]	50	50	50
Rated power [W]	170	170	125
Rated current [A]	0,8	0,8	0,7
Type of plug	Schuko	Schuko	Schuko
Power cord length [mm]	1500	1500	1800

(1) The actual energy consumption depends on the conditions of use of the device and its location, according to the results obtained in the standard test of 24 hours defined in EN 62552 regulation. (2) Type of climates: SN: from +10°C to +34°C, N: From +16°C to +32°C ambient temperature. ST: from +16°C to +38°C, T: From +16°C to +43°C ambient temperature.

8585	8586	8587	8579
8435025785854	8435025785861	8435025785878	8435025785793
HAIL 185 2TNF RR	TUNDRA TNF 177 BI	ICE TNF 177 BI	HAIL TNF 177 BI
Red	Integrable	Integrable	Integrable
7	3	8	7
E	F	F	E
225	125	285	185
245	255	-	164
81	-	203	68
4	-	4	4
Yes	Yes	-	Yes
Yes	-	Yes	Yes
8	-	15	15
3,5	-	10	3,5
SN-N-ST-T	SN-N-ST	SN-N-ST	SN-N-ST
40	42	42	42
Freestanding	Built-in	Built-in	Built-in
1832	1770	1770	1770
600	540	540	540
698	545	545	545
Right	Optional	Optional	Right
-	Yes	Yes	Yes
-	-	-	-
External	-	-	Recessed handle
Norfrost	Norfrost	Norfrost	Norfrost
Mechanical	Electronic	Electronic	Electronic
-	Yes	Yes	Yes
-	Nfreshzone	-	Nfreshzone
-	-	Yes	Nfreshzone
-	Nchilly/ -	- / Nsubzero	Nchilly/Nsubzero
-	-	-	Nsave
-	-	-	-
6	5	-	3
4	4	-	5
Yes	Yes	-	Yes
Ngreenbox	-	-	Ngreenbox
-	-	-	-
-	-	-	-
1-7	1-8	-	1-8
-	-	6 / 6	3 / 3
1-8	-	-	-
Yes / -	Yes	Yes	Yes
Yes	Yes	Yes	Yes
220-240	220-240	220-240	220-240
50	50	50	50
140	82	140	150
0,9	0,55	1,2	0,55
Schuko	Schuko	Schuko	Schuko
1800	1800	1800	1800

Code	8708	8709	8710
EAN	8435025787087	8435025787094	8435025787100
Model	DW6142 I SL	DW6141 I SL	DW4611 I SL
Finish	Built-in	Built-in	Built-in
Product fiche according to EU Regulation 2019/2022 - 2019/2017			
Model identifier	NorCare DW6142 I SL	NorCare DW6141 I SL	NorCare DW4611 I SL
Rated capacity (ps)	14	14	10
Height (cm)	81,5	81,5	81,5
Width (cm)	59,8	59,8	44,8
Depth (cm)	55	55	55
Energy Efficiency Index (EEI)	43,9	49,9	49,9
Energy efficiency class (1)	C	D	D
Cleaning performance index (IC)	1,13	1,13	1,13
Drying performance index (ID)	1,07	1,07	1,07
Energy consumption in kWh [per cycle], based on the ECO programme	0,747	0,849	0,674
Energy consumption in kWh [per 100 cycle], based on the ECO programme	74	84	67
Water consumption in litres [per cycle], based on the ECO programme	9,8	11	9
Duration of the eco programme (Tt) (h:min)	3:18	3:18	3:58
Type	Built-in	Built-in	Built-in
Airborne acoustical noise emissions (dB(A))	47	47	42
Airborne acoustical noise emission class	C	D	B
Power consumption in off-mode (Po) (W)	0,49	0,49	0,49
Power consumption in standby mode (Psm) (W)	-	-	-
Delay start (W) (if applicable)	1	1	1
Networked standby (W) (if applicable)	-	-	-
Product dimensions			
Height min/max [mm]	815/865	815/865	815/865
Width [mm]	598	598	448
Depth [mm]	550	550	550
Adjustable legs	Yes	Yes	Yes
Cabinet and door dimensions			
Minimum cabinet height [mm]	820	820	820
Minimum cabinet width [mm]	600	600	450
Minimum cabinet depth [mm]	580	580	580
Max door height (built-in models) [mm]	800	800	800
Sliding door	Nmove	Nmove	Nmove
Control panel			
Display / LED	Yes	Yes	Yes
Salt control pilot light	Yes	Yes	Yes
Rinse aid control pilot light	Yes	Yes	Yes
Time remaining indicator	Yes	Yes	Yes
Delay for starting operation	1-24 h	1-24 h	1-24 h
Programs and functions			
Number of programs	7	7	7
Nstorm [°C-min]	65 °C / 205 min	65 °C / 205 min	65 °C / 205 min
Ndaily [°C-min]	55 °C / 175 min	55 °C / 175 min	55 °C / 175 min
Nsave [°C-min] (2)	45 °C / 235 min	45 °C / 235 min	45 °C / 235 min
Nquick [°C-min]	60 °C / 90 min	60 °C / 90 min	60 °C / 90 min
Ncare [°C-min]	50 °C / 120 min	50 °C / 120 min	50 °C / 120 min
Express [°C-min]	-	-	-
Nfresh [min]	15 min	15 min	15 min
Automatic [°C-min]	55-65°C, 90-180 min	55-65°C, 90-180 min	55-65°C, 90-180 min
Start / Pause function	Yes	Yes	Yes
Half load function	Nby2	Nby2	Nby2
Extra drying function	Yes	Yes	Yes
Equipment			
Third Cutlery Basket	Yes	Yes	Yes
Upper basket with height regulation	Npush	Npush	Npush
Upper basket foldable support for cups	No	Yes	Yes
Upper/Lower basket foldable supports	Yes	Yes	Yes
Type of dispenser	Nslider	Nslider	Nslider
Additional specifications			
Motor	Standard	BLDC Inverter	Standard
Automatic door open	Yes	Yes	Yes
Enabled for all in one detergent	Yes	Yes	Yes
Type of cavity	Stainless steel	Stainless steel	Stainless steel
Safety			
Child lock	-	-	-
Overflow Protection	N3protect	N3protect	N3protect
Overheating protection	N3protect	N3protect	N3protect
Power and water connection			
Voltage range [V]	220-240	220-240	220-240
Frequency [Hz]	50	50	50
Rated power [W]	1760-2100	1760-2100	1760-2100
Rated current [A]	8-8.75	8-8.75	8-8.75
Type of plug	Schuko	Schuko	Schuko
Power cord length [mm]	1500	1500	1500
Inlet water hose length [mm]	1500	1500	1500
Drain water hose length [mm]	1400	1400	1400

(1) A (highest efficiency) to G (lowest efficiency).

(2) This program is suitable for cleaning soiled normally soiled tableware and that it is the most efficient programme in terms of its combined energy and water consumption for that type of tableware.

Code	4198	4199
EAN	8435025741980	8435025741997
Model	WD1480 I	WM1480 I
Finish	Built-in	Built-in
Product fiche according to EU Regulation 2019/2023		
Model identifier	NorCare WD1480 I	NorCare WM1480 I
Rated capacity (kg)	8-6	8
Height (cm)	83	83
Width (cm)	60	60
Depth (cm)	54	54
Energy Efficiency Index (EEI)	60-78,4	60
Energy efficiency class (1)	B-E	B
Cleaning performance index	1,04 - 1,04	1,04
Rinsing effectiveness (g/kg)	5 - 5	5
Energy consumption in kWh [per cycle], based on the ECO programme	0,545 - 3,6	0,545
Water consumption in litres [per cycle], based on the ECO programme	48 - 90	48
Maximum temperature inside the treated textile (°C) - Rated Capacity	38	37
Maximum temperature inside the treated textile (°C) - Half Capacity	38	33
Maximum temperature inside the treated textile (°C) - Quarter Capacity	21	23
Remaining moisture content (%) - Rated capacity	53	53
Remaining moisture content (%) - Half capacity	53	53
Remaining moisture content (%) - Quarter capacity	53	53
Spin speed (rpm) - Rated capacity	1400	1400
Spin speed (rpm) - Half capacity	1400	1400
Spin speed (rpm) - Quarter capacity	1400	1400
Spin-drying efficiency class (2)	B	B
Programme duration (h:min) - Rated capacity	3 : 38 - 9:30	3 : 38
Programme duration (h:min) - Half capacity	2 : 48 - 6:40	2 : 48
Programme duration (h:min) - Quarter capacity	2 : 48	2 : 48
Type	Built-in	Built-in
Airbone acoustical noise emissions in the spinning phase (dBA)	76	76
Airbone acoustical noise amision class (sprinning phase)	B	B
Off-mode (W)	0,50	0,50
Standby mode (W)	1	1
Delay start (W)	4	4
Product dimensions		
Height min/max [mm]	830/850	830/850
Width [mm]	590	590
Depth [mm]	540	540
Adjustable legs	Yes	Yes
Cabinet and door dimensions		
Minimum cabinet height [mm]	840	840
Minimum cabinet width [mm]	600	600
Minimum cabinet depth [mm]	580	580
General features		
Loading type	Front	Front
Motor type	Silence Inverter	Silence Inverter
Hatch door diameter [cm]	31	31
Drum type	Stainless Steel	Stainless Steel
Filter system	Accessible	Accessible
Foam reduction system	Accessible	Accessible
Load self adjustment	Yes	Yes
Control		
Control type	LED Digital Display	LED Digital Display
Independent washing temperature selection	Yes	Yes
Independent spinning speed selection	Yes	Yes
Delay start [h]	Yes	Yes
Start / Pause key	Yes	Yes
Countdown display	Yes	Yes
Washing cycle display	Yes	Yes
Programmes		
N° of programmes	16	16
Cotton	Yes	Yes
Sintetic	Yes	Yes
Delicates	Yes	Yes
ECO	Yes	Yes
Wool	Yes	Yes
Hand wash	Yes	Yes
Quick [min]	Yes	Yes
Mix	Yes	Yes
Sport clothes	Yes	Yes
Baby clothes	Yes	Yes
Customized	Yes	Yes
Special functions		
Prewash	Yes	Yes
Extra rinse	Yes	Yes
Safety		
Child-lock door	Yes	Yes
Anti-flooding system	Yes	Yes
Power and water connection		
Voltage range [V]	220-240	220-240
Frecuency [Hz]	50	50
Rated power [W]	1.900	1.950
Rated current [A]	10	10
Type of plug	Schuko	Schuko
Power cord length [mm]	1,5	1,5
Inlet water hose length [mm]	1	1
Drain water hose length [mm]	1,6	1,6

(1) Class range from A (more efficient) to G (less efficient).

(2) Class range from A (more efficient) to G (less efficient).

Code	4184	4191	4190
EAN	8435025741844	8422248101820	8422248101813
Model	VC 4800 DB /A	V36 BK	V28BK
Finish	Black	Black	Black
Product fiche according to EU Regulation 2019/2016			
Category	Compressor wine cooler	Compressor wine cooler	Compressor wine cooler
Energy efficiency class	F	G	G
Energy consumption [kWh/year]	99	140	135
Refrigerator storage volume [bottles]	24	36	28
Climate class	SN-N-ST	SN-N-ST	SN-N-ST
Noise emissions [dBA]	43	41	40
Installation type	Built-in	Built-in	Built-in
Technical specs and control type			
Refrigerator system	Compressor	Compressor	Compressor
Display	Touch control display on frontal panel	Touch control display on frontal panel	Touch control display on frontal panel
Wine cooler lighting	Led	Led	Led
Temperature zones	1	2	1
Temperature ranges (°C)	5-20	5-22	5-20
Storage levels	4	4	3
Capacity (bottles)	24	36	28
Opening of the door	Folding door	Right	Right
Reversible doors	No	Yes	Yes
Adjustable feet	No	Yes	Yes
Dimensions			
Height [mm]	455	595	455
Width [mm]	595	590	590
Depth [mm]	533	545	545
Cabinet dimensions			
Minimum cabinet height [mm]	450	590	450
Minimum cabinet width [mm]	565	560	560
Minimum cabinet depth [mm]	555	550	550
Power connection			
Voltage range [V]	220-240	220-240	220-240
Frecuency [Hz]	50	50	50
Rated power [W]	80	65	65
Type of plug	-	Schuko	Schuko
Power cord length [mm]	1200	1500	1500

Note (I) Flow path must be made even if the winecooler is located between appliances and/or cabinets. Air vents must be located on the top and bottom of the entire column.

TAPS

Code	4095	4096	4097	4098
EAN	8435025740952	8435025740969	8435025740976	8435025740983
Model	BLACKBIRD BK	BLACKBIRD WH	BLACKBIRD RD	ROBIN BK
Dimensions				
Dimensions (diameter, length) of spout braided hose [", mm]	M10*G3/8*500mm	M10*G3/8*500mm	M10*G3/8*500mm	M10*G3/8*500mm
Product dimensions (height x width x depth) [mm]	535x100x265	535x100x265	535x100x265	280x265x100
General features				
Water tap type	Single-lever	Single-lever	Single-lever	Single-lever
Material	Stainless steel 304	Stainless steel 304	Stainless steel 304	Stainless steel 304
Material of handle	Stainless steel 304	Stainless steel 304	Stainless steel 304	Stainless steel 304
Material of spout braided hose	Plastic	Plastic	Plastic	-
Finish style	Satin	Satin	Satin	Satin
Instalation place	Sink, Worktop	Sink, Worktop	Sink, Worktop	Sink, Worktop
Spout and control details				
Spout type	Long	Long	Long	Long
Spout form	Semi-professional	Semi-professional	Semi-professional	L form
Removable spout	Yes	Yes	Yes	No
Rotatory spout	360°	360°	360°	360°
Airy spout	Yes	Yes	Yes	Yes
Shower function	Yes	Yes	Yes	No
Control type	Handle	Handle	Handle	Handle
Control position	Right side	Right side	Right side	Right side
Accessories				
Cartridge type	Ceramic	Ceramic	Ceramic	Ceramic
Installation triangle	Yes	Yes	Yes	Yes
Coloured handle	No	No	No	Black

4099	4100	3600	3558	3552	3589
8435025740990	8435025741003	8435025736009	8435025735583	8435025735521	8435025735897
ROBIN SS	ROBIN CU	DENALÍ EXTENSIBLE	IBIS INOX	TUCÁN INOX	TUCÁN R
M10*G3/8*500mm	M10*G3/8*500mm	M10*G3/8*500mm	M10*G3/8*500mm	M10*G3/8*500mm	M10*G3/8*500mm
280x265x100	280x265x100	285x58x240	380x58x240	366x110x240	290x110x220
Single-lever	Single-lever	Single-lever	Single-lever	Single-lever	Single-lever
Stainless steel 304	Stainless steel 304	Stainless steel	Stainless steel	Stainless steel	Stainless steel
Stainless steel 304	Stainless steel 304	Cast iron	Stainless steel	Cast iron	Cast iron
-	-	Stainless steel	-	-	-
Satin	Satin	Chrome	Satin	Satin	Chrome
Sink, Worktop	Sink, Worktop	Sink, Worktop	Sink, Worktop	Sink, Worktop	Sink, Worktop
Long	Long	Long	Long	Long	Long
L form	L form	L form	Semi-professional	L form	L form
No	No	Yes	No	No, Rotary	No
360°	360°	360°	360°	360°	360°
Yes	Yes	Yes	Yes	Yes	Yes
No	No	No	No	No	No
Handle	Handle	Handle	Handle	Handle	Handle
Right side	Right side	Right side	Front	Front	Front
Ceramic	Ceramic	Ceramic	Ceramic	Ceramic	Ceramic
Yes	Yes	No	No	No	No
No	Copper	No	No	No	No

Code	4067	4069	4068	4061
EAN	8435025740679	8435025740693	8435025740686	8435025740617
Model	100.50 1B 1/2B 1D BK	100.50 1B 1/2B 1D WH	100.50 1B 1/2B 1D BG	86.50 1B 1D BK
Dimensions				
Furniture measurement (length x width) [mm]	980mm x 480mm	980mm x 480mm	980mm x 480mm	840mm x 480mm
Dimensions (length x width x depth) [mm]	1000mm X 500mm	1000mm X 500mm	1000mm X 500mm	860mm X 500mm
General features				
Type of sink	Built-in countertop	Built-in countertop	Built-in countertop	Built-in countertop
Material	Quarz composite	Quarz composite	Quarz composite	Quarz composite
Bowl thickness [mm]	7	7	7	7
Colour	Black	White	Beige	Black
Bowl and draining rack details				
Bowl quantity	1 + 1/2	1 + 1/2	1 + 1/2	1
Bowl form	Square	Square	Square	Square
Draining rack	Yes	Yes	Yes	Yes
Tap hole	No, inner mark	No, inner mark	No, inner mark	No, inner mark
Accessories				
Drainpipe type	Round 3 1/2"	Round 3 1/2"	Round 3 1/2"	Round 3 1/2"
Drainpipe quantity	2	2	2	1
Overflow tube	Yes	Yes	Yes	Yes

Code	4071	4079	4081	4080
EAN	8435025740716	8435025740792	8435025740815	8435025740808
Model	86.50 2B BG	78.50 1B BK	78.50 1B WH	78.50 1B BG
Dimensions				
Furniture measurement (length x width) [mm]	840mm x 480mm	764mm x 494mm	764mm x 494mm	764x494
Dimensions (length x width x depth) [mm]	860mm X 500mm	780mm X 510mm	780mm X 510mm	780x510
General features				
Type of sink	Built-in countertop	Built-in countertop	Built-in countertop	Built-in countertop
Material	Quarz composite	Quarz composite	Quarz composite	Quarz composite
Bowl thickness [mm]	7	7	7	7
Colour	Beige	Black	White	Beige
Bowl and draining rack details				
Bowl quantity	2	1	1	1
Bowl form	Square	Square	Square	Square
Draining rack	No	No	No	No
Tap hole	No, inner mark	No, inner mark	No, inner mark	No, inner mark
Accessories				
Drainpipe type	Round 3 1/2"	Round 3 1/2"	Round 3 1/2"	Round 3 1/2"
Drainpipe quantity	2	1	1	1
Overflow tube	Yes	Yes	Yes	Yes

Code	4090	4089	4076	4078
EAN	8435025740907	8435025740891	8435025740761	8435025740785
Model	40.40 1B WH	40.40 1B BG	Oval 51.20 1B BK	Oval 51.20 1B WH
Dimensions				
Furniture measurement (length x width) [mm]	407x407 (Top Mount) 356x356 (Undermount)	407x407 (Top Mount) 356x356 (Undermount)	Ø 490	Ø 490
Dimensions (length x width x depth) [mm]	423x423	423x423	Ø510	Ø510
General features				
Type of sink	Built-in/Under countertop	Built-in/Under countertop	Built-in countertop	Built-in countertop
Material	Quarz composite	Quarz composite	Quarz composite	Quarz composite
Bowl thickness [mm]	7	7	7	7
Colour	White	Beige	Black	White
Bowl and draining rack details				
Bowl quantity	1	1	1	1
Bowl form	Square	Square	Round	Round
Draining rack	No	No	No	No
Tap hole	No	No	No, inner mark	No, inner mark
Accessories				
Drainpipe type	Round 3 1/2"	Round 3 1/2"	Round 3 1/2"	Round 3 1/2"
Drainpipe quantity	1	1	1	1
Overflow tube	Yes	Yes	Yes	Yes

4063	4062	4058	4060	4059	4070	4072
8435025740631	8435025740624	8435025740587	8435025740600	8435025740594	8435025740709	8435025740723
86.50 1B 1D WH	86.50 1B 1D BG	78.50 1B 1D BK	78.50 1B 1D WH	78.50 1B 1D BG	86.50 2B BK	86.50 2B WH
840mm x 480mm	840mm x 480mm	765mm x 485mm	765mm x 485mm	765mm x 485mm	840mm x 480mm	840mm x 480mm
860mm X 500mm	860mm X 500mm	780mm X 500mm	780mm X 500mm	780mm X 500mm	860mm X 500mm	860mm X 500mm
Built-in countertop	Built-in countertop	Built-in countertop	Built-in countertop	Built-in countertop	Built-in countertop	Built-in countertop
Quarz composite	Quarz composite	Quarz composite	Quarz composite	Quarz composite	Quarz composite	Quarz composite
7	7	7	7	7	7	7
White	Beige	Black	White	Beige	Black	White
1	1	1	1	1	2	2
Square	Square	Square	Square	Square	Square	Square
Yes	Yes	Yes	Yes	Yes	No	No
No, inner mark	No, inner mark	No, inner mark	No, inner mark	No, inner mark	No, inner mark	No, inner mark
Round 3 1/2"	Round 3 1/2"	Round 3 1/2"	Round 3 1/2"	Round 3 1/2"	Round 3 1/2"	Round 3 1/2"
1	1	1	1	1	2	2
Yes	Yes	Yes	Yes	Yes	Yes	Yes

4085	4087	4086	4082	4084	4083	4088
8435025740853	8435025740877	8435025740860	8435025740822	8435025740846	8435025740839	8435025740884
55.40 1B BK	55.40 1B WH	55.40 1B BG	45.40 1B BK	45.40 1B WH	45.40 1B BG	40.40 1B BK
594x442 (Top Mount) 543x393 (Undermount)	594x442 (Top Mount) 543x393 (Undermount)	594x442 (Top Mount) 543x393 (Undermount)	518x442 (Top Mount) 468x391 (Undermount)	518x442 (Top Mount) 468x391 (Undermount)	518x442 (Top Mount) 468x391 (Undermount)	407x407 (Top Mount) 356x356 (Undermount)
610x460	610x460	610x460	533x457	533x457	533x457	423x423
Built-in/Under countertop	Built-in/Under countertop	Built-in/Under countertop	Built-in/Under countertop	Built-in/Under countertop	Built-in/Under countertop	Built-in/Under countertop
Quarz composite	Quarz composite	Quarz composite	Quarz composite	Quarz composite	Quarz composite	Quarz composite
7	7	7	7	7	7	7
Black	White	Beige	Black	White	Beige	Black
1	1	1	1	1	1	1
Square	Square	Square	Square	Square	Square	Square
No	No	No	No	No	No	No
No	No	No	No	No	No	No
Round 3 1/2"	Round 3 1/2"	Round 3 1/2"	Round 3 1/2"	Round 3 1/2"	Round 3 1/2"	Round 3 1/2"
1	1	1	1	1	1	1
Yes	Yes	Yes	Yes	Yes	Yes	Yes

4077	4093	4091	4092	4094
8435025740778	8435025740938	8435025740914	8435025740921	8435025740945
Oval 51.20 1B BG	70.40 1C R10 CP	50.40 1C R10 CP	45.40 1C R10 CP	40.40 1C R10 CP
Ø 490				
Ø510	740x440x200	540x440x200	490x440x200	440x440x200
Built-in countertop	Built-in/Under countertop	Built-in/Under countertop	Built-in/Under countertop	Built-in/Under countertop
Quarz composite				
7	1	1	1	1
Beige	SS	SS	SS	SS
1	1	1	1	1
Round	Square	Square	Square	Square
No	No	No	No	No
No, inner mark				
Round 3 1/2"	Round 3 1/2"	Round 3 1/2"	Round 3 1/2"	Round 3 1/2"
1				
Yes				





CATA ELECTRODOMÉSTICOS S.L.

Tlf: +34 938 594 100.- Fax +34 938 594 101.

www.cata.es - www.cnagroup.es - cna@cnagroup.es

Headquarters: c/ Anabel Segura, 11, Edif. A, 3a pl. 28108. Alcobendas (Madrid. Spain)

Factory: c/ del Ter, 2, Apdo. 9. 08570. Torelló (Barcelona. Spain)

CNA
group

cata

edesa

NODOR

Apelson