

UNICO 500

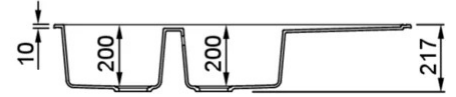

Méretrajz

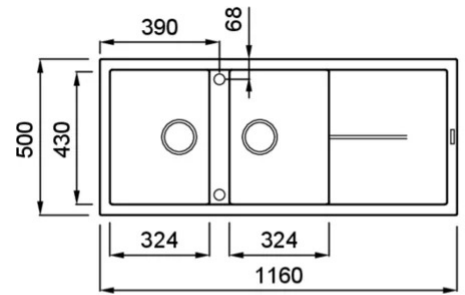

| | |
|---------------------|-------------------------|
| 0 | |
| Jelleg | 2 medence csepegtetővel |
| modell | UNICO 500 |
| Székrenyméret (mm) | 800 |
| Béépíthetőség | Munkalapra szerelhető |
| Méreték (mm) | 1160 x 500 |
| Kivágási méret (mm) | 1140 x 480 |



KERATEK[®] plus
CERAMIC NANOTECHNOLOGY CN6

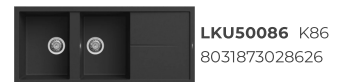
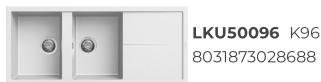
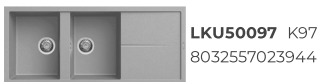

GRANITEK[®]
NATURAL GRANITE EFFECT

METAL

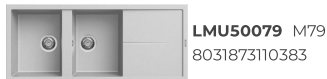
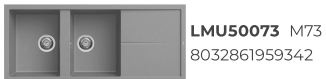

MATT



LGU50040 G40
8032557032908



LGU50043 G43
8032557032922



LGU50048 G48
8032557032946



LGU50068 G68
8032557032885



LGU50078 G78
8032557067320

CLASSIC



LGU50051 G51
8032557032861



LGU50059 G59
8032557036227



LGU50062 G62
8032557038283

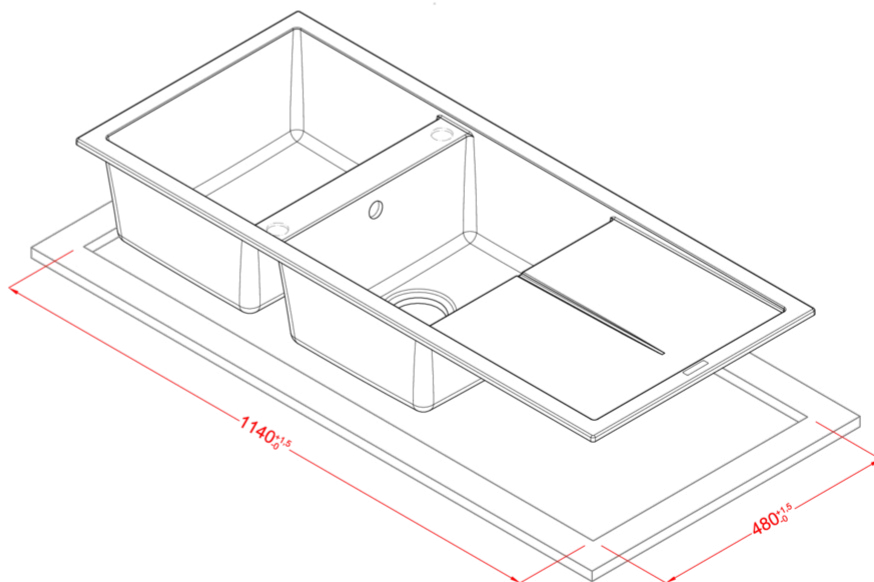
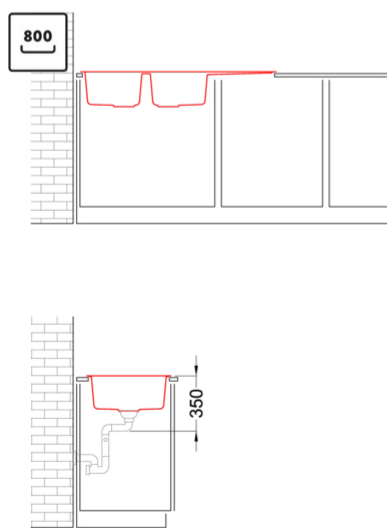
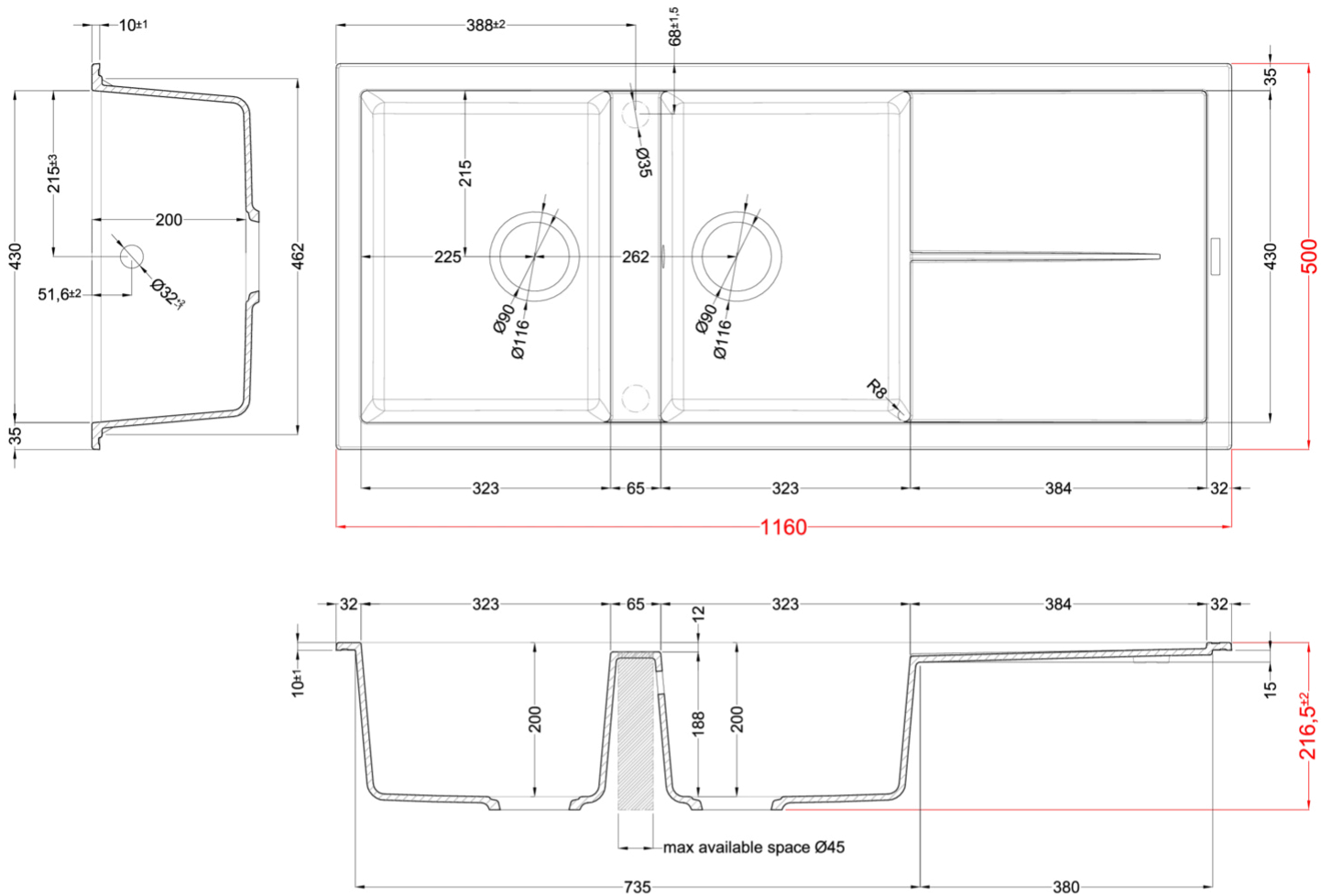

UNICO 500

general tolerances where not expressly communicated ±0.2%
connection dimensions according to UNI EN 695

