

LAB

P R E

to make
the most of
every moment

C I O

the power
of a vision for
a new space
performance

LIFE_
STYLE
IS HERE.

U S



Precious. Lifestyle is here.

PREZIOSO

/pre.zi.ó.so/
aggettivo

[dal lat. pretiosus (der. di pretium «pregio»)

- ◊ Che ha grande valore, grande pregio.
- ◊ Per estens., di tutto ciò che è particolarmente apprezzato e considerato, sia perché dotato di pregevoli caratteristiche, sia perché necessario in determinate circostanze e scopi.

_La workstation Elleci è preziosa per il benessere quotidiano e la condivisione dei momenti vissuti in casa.

PRECIOUS

/preʃəs/
adjective

[from Latin pretiosus (derived from pretium 'value, worth')

- ◊ Which has great value, great worth.
- ◊ By extension, everything that is particularly valued and appreciated, either because it is endowed with valuable characteristics or because it is necessary in certain circumstances and for certain purposes.

_Elleci's workstation is a precious asset in achieving well-being every day and sharing moments at home.

30TH
ANNIVERSARY

UNA STORIA DA RACCONTARE, UN'ESPERIENZA DA CONDIVIDERE.
A STORY TO TELL, AN EXPERIENCE TO SHARE.



MADE IN ITALY

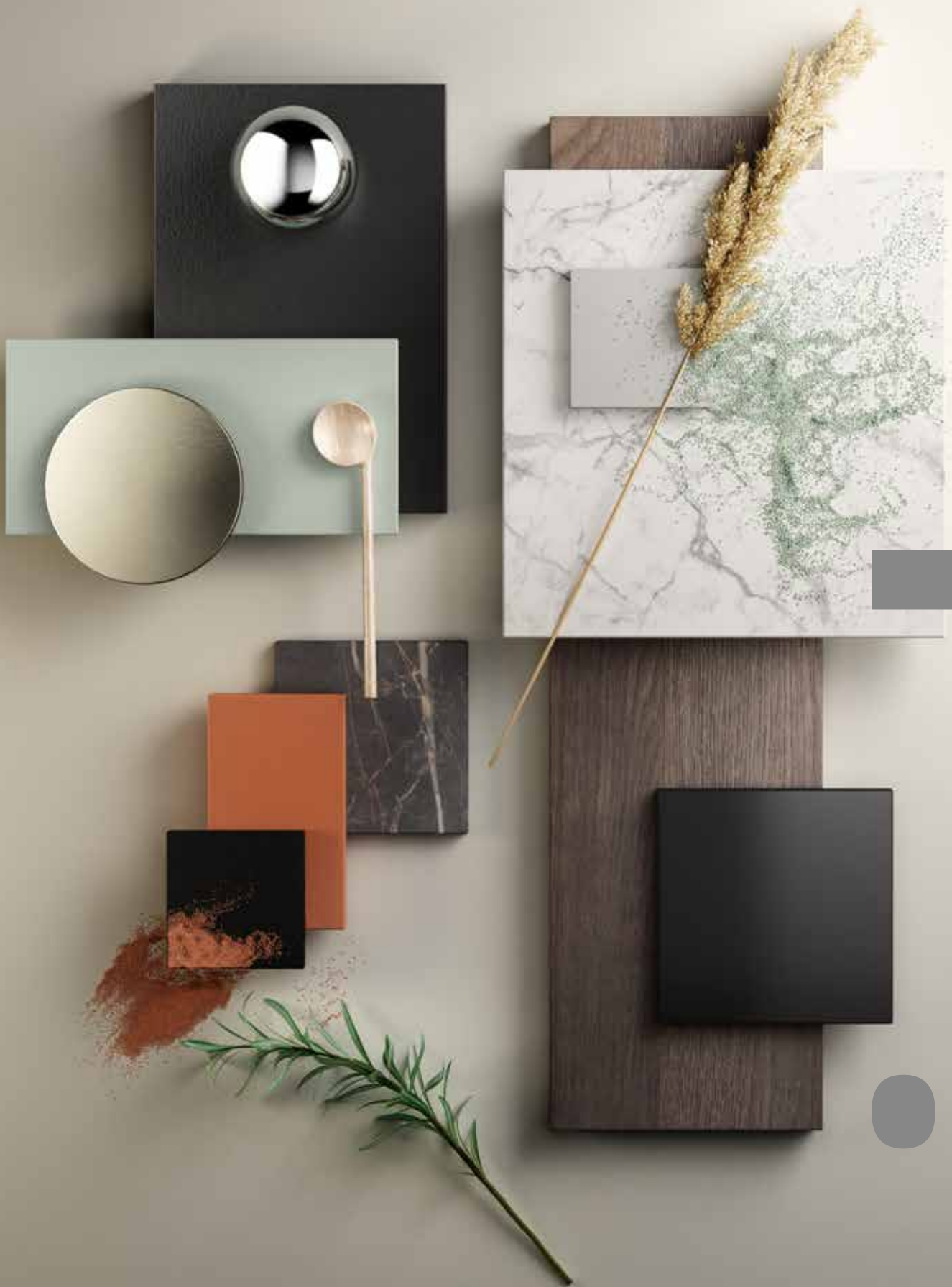

Y
e
r
i

K
B
S
E
E
E

_Questo è un invito esclusivo.
La chiave di lettura per accedere ad un mondo fatto di appassionata ricerca, esemplare qualità e materiali all'avanguardia.
_Non resta che aprire la porta ed entrare.
Il futuro è proprio qui, dietro l'angolo.

_This is an exclusive invitation.
The key to access a world made of passionate research, exemplary quality and cutting-edge materials.
All that remains is to open the door and enter.
_The future is right here, just around the corner.

05 **RIVOLUZIONE DELL' IDEA DOMESTICA**
R-EVOLUTION OF THE DOMESTIC CONCEPT

10 **KERATEK PLUS**

24 **DIALOGO**

34 **SINKS**

35 **ACCESSORIES**

38 **SINTESI**

50 **SINKS**

53 **ACCESSORIES**

56 **BEST workstation black edition**

64 **SINKS**

66 **ACCESSORIES**

68 **ZEN limited edition**

76 **SINKS**

80 **ACCESSORIES**

72 **ZEN F limited edition**

78 **SINKS**

80 **ACCESSORIES**

82 **MISCELATORI KITCHEN TAPS**

88 **PIANI COTTURA COOKING HOBS**

philosophy

LAB - È uno spazio fatto di ricerca e tecnologia dove nuove soluzioni prendono vita. Il design del prodotto ridefinisce gli spazi secondo principi di funzionalità ed ergonomia in cui le strutture geometriche e vari livelli di lavoro interagiscono tra loro assicurando un'esperienza di preparazione unica. Una rivoluzione dei gesti, che si integra ad un'organizzazione razionale del vivere in cucina. *Un vero e proprio laboratorio all'avanguardia che realizza oggi i desideri di domani.*

LAB – a space created for research and technology where new solutions come to life. The design of the product redefines spaces according to principles based on functionality and ergonomics, with geometric structures and different work levels interacting to provide a unique food-preparation experience. A revolution in movements, merging seamlessly with a rational process for living in the kitchen. *A true state-of-the-art laboratory, making tomorrow's dreams come true today.*



R-EVOLUTION OF THE DOMESTIC CONCEPT.

RIVOLUZIONE DELL'IDEA DOMESTICA.

**Gusto e convivialità,
preparazione e piacere.
Tutto a portata di mano.
La cucina dalle molteplici
soluzioni professionali entra
di rito tra i must-have
del vivere contemporaneo.
_Con strumenti ed accessori
evoluti il lavello diventa
il perfetto baricentro della
cucina, ridisegnando l'agire
domestico per un'esperienza
di preparazione migliorata.
Non resta che rilassarsi
e godersi il momento.**

Flavours and laughter,
preparation and convenience.
Everything at your fingertips.
A kitchen with a dazzling
array of professional
solutions is one
of the must-haves of
contemporary living.
_With advanced tools
and accessories, the sink
becomes the very heart
of the kitchen, redefining
the simplest domestic
tasks to provide an amazing
food-preparation experience.
All you have to do is relax
and enjoy the moment.

**MODULARITÀ E FLESSIBILITÀ PER
INFINITE SOLUZIONI IN UN UNICO SPAZIO.**

MODULARITY AND FLEXIBILITY FOR
INFINITE SOLUTIONS IN ONE SPACE.

**- COMPLESSITÀ
+ PIÙ VALORE
= DESIGN DEL PRODOTTO
UNICO PER SOLUZIONI
UOMO-SPAZIO ARMONIOSE.**

**- COMPLEXITY
+ MORE VALUE
= UNIQUE PRODUCT
DESIGN FOR HARMONIOUS
MAN-SPACE SOLUTIONS.**

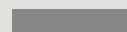

EVERYTHING WITH IN REACH FOR A BETTER LIFESTYLE EXPERIENCE.

**LA POTENZA DELL'ERGONOMIA
PER UNA POSTAZIONE ALL-IN-ONE.**

THE POWER OF ERGONOMICS
CREATING AN ALL-IN-ONE WORKSTATION.



TUTTO INTORNO,
PER UNA MIGLIORE
ESPERIENZA DEGLI SPAZI.

**Il miscelatore diventa discreto.
Con la funzione di abbattimento potrà
essere posizionato anche sotto finestra.**

The kitchen taps are so discreet.
And their retractable design means they
can also be positioned under the window.

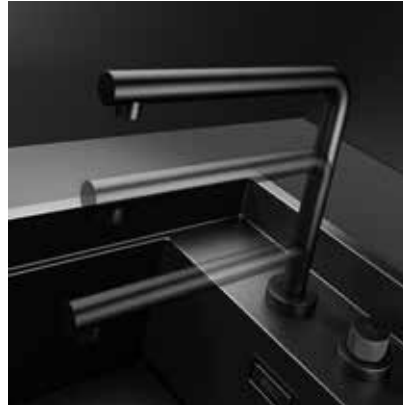

**Dissipatore di rifiuti organici.
Silenzioso ed integrato.**

Organic waste disposal unit.
Silent and integrated.



***_Tutti gli strumenti sono intorno
ed il flusso di lavoro è un processo
in divenire equilibrato in cui l'area
lavaggio e la zona preparazione
si uniscono in un'unica soluzione.
Accessori dalle geometrie studiate
ad hoc si incastrano nel lavello,
come il mixer abbattibile
e il dissipatore di rifiuti organici
che elevano l'esperienza in cucina.
Uno spazio configurabile in base
alle necessità, diventa teatro
dinamico di gestualità semplificate:
_tutto per il piacere di movimenti
bilanciati e mai superflui.***

*_All the tools are within reach and
the workflow is a rational process
where the washing and preparation
areas create a single seamless space.
Specially designed accessories fit
into the sink, including retractable
kitchen taps and organic waste
disposal units that enhance
the cooking experience.
A space that can be configured
just how you need, transformed
into a dynamic area where actions
flow one from another:
_the simple joy of movements
in harmony that are never more
than exactly what you need.*

**PER VALORIZZARE AL MEGLIO
OGNI MOMENTO.**

elleci | LAB





elleci_to make the most

TO MAKE THE MOST OF EVERY MOMENT.

**COSÌ COME L'ACQUA DAL MISCELATORE,
COSÌ LO SCORRERE DEL TEMPO;
L'OBIETTIVO È GODERSI OGNI MOMENTO.
UN'ESPERIENZA QUOTIDIANA,
CARATTERIZZATA DA DESIGN MINIMALISTA
E MATERIALI DI MASSIMA QUALITÀ
CHE STENDONO LA BASE PER OSPITARE
OGNI TIPO DI LIFESTYLE.**

***_L'ATTENZIONE SI SPOSTA DALLA
PREPARAZIONE AI MOMENTI DI SOCIALITÀ
GRAZIE AD UNA POSTAZIONE OPERATIVA
D'AVANGUARDIA CHE SEMPLIFICA
AL MASSIMO MOVIMENTI E GESTUALITÀ.***

JUST AS WATER FLOWS FROM
A KITCHEN TAP, SO FLOWS THE PASSAGE
OF TIME, AND THE AIM IS TO REALLY LIVE
EVERY MOMENT. A DAILY EXPERIENCE,
CHARACTERISED BY MINIMALIST DESIGN
AND TOP-QUALITY MATERIALS THAT LAY
THE FOUNDATION FOR EVERY LIFESTYLE.

*_THE FOCUS SHIFTS FROM PREPARATION
TO MOMENTS OF SOCIAL INTERACTION
THANKS TO A STATE-OF-THE-ART WORKSTATION
THAT REQUIRES ONLY THE SIMPLEST
OF ACTIONS AND MOVEMENTS.*



KERATEK[®] PLUS

CERAMIC NANOTECHNOLOGY CN6

DOES MATTER

La materia ultracompatta, plasmata attraverso la più avanzata nanotecnologia, è qui. Quarzo, particelle di ceramica ed un mix di innovative resine acriliche si fondono in Keratek Plus attraverso processi esclusivi in grado di riempire completamente la struttura interna.

„Sostanza e rivelazione: il prodotto nato dalla cultura della materia emerge silenzioso, rivoluzionando ogni cosa.

Con una superficie a zero porosità che assicura la massima igienicità ed una sorprendente resistenza agli agenti macchianti, vivere la quotidianità non è mai stato così entusiasmante.

This ultra-compact material, shaped using the most advanced nanotechnology, is finally here. Quartz, ceramic particles and a mix of innovative acrylic resins are combined in Keratek Plus using exclusive processes capable of completely filling the material's internal structure.

„Substance and revelation: a product born through materials development emerges silently, and everything is revolutionised. With a zero-porosity surface that ensures maximum hygiene and surprising resistance to staining agents, living the everyday has never been so exciting.



EASY TO CLEAN



WATER REPELLENT



IMPACT RESISTANT



THERMAL SHOCK RESISTANT



MADE TO LAST



HYGIENE GUARD



Keratek Plus is certified for the requirements of NSF/ANSI 51 Food Equipment Material



Product certified for low chemical emissions
ul.com/gg-ul2818



SINTESI 130
K86 Black, K96 White, K82 Sage Green,
K97 Light Grey, K83 Cavern Clay.

MATERIA DAL FASCINO ETERNO.

_Vista e tatto si uniscono in un unico viaggio sensoriale con cinque colorazioni dalla struttura piena, densa e vivida che completano il profilo della materia Keratek Plus. Caratterizzata dall'eccellente anima strutturale, la superficie mantiene le stesse caratteristiche presentandosi estremamente liscia, immediata nella pulizia e resistente ad urti e shock termici.

_Sight and touch come together in a single sensory journey with five colours with a full, dense and vivid structure that complete the profile of the Keratek Plus material. Characterised by its excellent structural core, the surface retains the same features and is extremely smooth, easy to clean and resistant to impact and thermal shock.

MATTER WITH EVERLASTING CHARM.



**L'ESPERIENZA CHE COINVOLGE I SENSI:
PERFORMANCE ED ESTETICA
IN UN'UNICA SOLUZIONE.**

THE EXPERIENCE THAT ENGAGES
THE SENSES: PERFORMANCE
AND AESTHETICS INTO ONE.

ENDLESS SPACE FOR AN AMAZING FAMILY FEELING.

SPAZIO INFINITO
PER UN **FAMILY FEELING**
ECCEZIONALE.

Per vivere la cucina come continuum della propria individualità. Dalla scelta della configurazione, degli accessori e del colore, tutto concorre a rispecchiare la propria personalità. Un family feeling tutto da progettare con finiture metalliche che risvegliano un nuovo modo di vedere il trend in cucina.

_Il lavello diventa co-protagonista delle geometrie della casa integrandosi con il piano ed aggiungendo stile ad ogni situazione.

Experience the kitchen as a reflection of your own individuality. From the choice of configuration, accessories and colours, everything helps to channel your distinct personality. A family feeling that can be designed using metallic finishes that awaken a new way of looking at kitchen trends. *_The sink is an integral part of the geometry of the house, becoming one with the worktop and adding style to every situation.*

Sintesi 510 K96 White | Stream Plus GD Gold





elleci_mix & match



MIX & MATCH
PREZIOSO ED
UN LOOK UNICO.



PRECIOUS MIX & MATCH AND A UNIQUE LOOK.

L'UNIONE FA LA FORZA.

*_ UN SOLO LOOK FORMATO DA PIÙ
COMBINAZIONI FINITURA PER
UN'ELEGANZA UNICA ED INDIVIDUALE.
ABBINARE LE 3 DIVERSE FINITURE
NON È MAI STATO PIÙ SEDUCENTE:
GOLD, NERO E INOX ACCENTUANO
LE FORME ESTETICHE DEGLI ACCESSORI
CUCINA IMPREZIOSENDO OGNI LORO
DETTAGLIO. PER UN ASPETTO MODERNO
ED AFFASCINANTE, TRE È MEGLIO DI UNO.*

UNITY IS STRENGTH.

*_ A SINGLE LOOK MADE UP
OF MULTIPLE FINISH COMBINATIONS
FOR A UNIQUE AND INDIVIDUAL ELEGANCE.
COMBINING THE THREE DIFFERENT FINISHES
HAS NEVER BEEN MORE SEDUCTIVE:
GOLD, BLACK AND STAINLESS STEEL
ACCENTUATE THE AESTHETIC SHAPES
OF THE KITCHEN ACCESSORIES,
EMBELLISHING EVERY DETAIL.
FOR A MODERN, GLAMOROUS LOOK,
THREE IS DEFINITELY BETTER THAN ONE.*



OPEN UP

COMANDO REMOTO
AUTOMATICO
DISPONIBILE SU RICHIESTA
IN VERSIONE KIT.

AUTOMATIC REMOTE
PUSH CONTROL
AVAILABLE ON REQUEST
IN KIT VERSION.

FLOW PRO

CAMBIA IL CONCETTO
DI PILETTA IN UN SISTEMA
DI SCARICO MODERNO,
PRATICO E SEMPLICE
NELL'UTILIZZO E NELLA
MANUTENZIONE.

TRANSFORMING THE
DRAINAGE CONCEPT INTO
A MODERN SYSTEM THAT
IS PRACTICAL AND EASY TO
USE AND MAINTAIN.

*L'eccellenza risiede
nei più piccoli dettagli.
Con la massima attenzione
alla funzionalità ed al design
del prodotto, il sistema
di scarico cambia aspetto.
La piletta dallo stile ricercato
garantisce una continuità
estetica all'interno della vasca
mentre l'ergonomia del comando
centrale ne favorisce l'utilizzo.*

*Excellence lies
in the smallest details.
By focusing specifically
on the functionality and design
of the product, we have created
a waste system with a completely
new appearance. The stylish
waste provides aesthetic
continuity within the bowl,
while the ergonomic central
control makes it easy to use.*

WORKING TOGETHER TO ACHIEVE MAXIMUM EFFICIENCY.

GLI ALLEATI DELLA MASSIMA EFFICIENZA.

SEMPLICEMENTE GENIALE.

Il silenzioso dissipatore di rifiuti DRA è un vero e proprio elettrodomestico che permette di tritare e smaltire i rifiuti direttamente dalla workstation; riducendoli in piccole parti, verranno scaricati direttamente nel sistema idrico.

SIMPLY BRILLIANT.

The silent waste disposal unit is a vital household appliance that allows you to chop and dispose of waste directly from the workstation. Because the waste is broken down into very small pieces, it can be discharged directly into the waste water system.

► Dissipatore di rifiuti organici
Organic waste disposal unit





◀ Piletta Flow Pro
Flow Pro waste

INSTALLATION STYLES.

STILI DI **INSTALLAZIONE.**

SOTTO TOP_ UNDERMOUNT

- 
SOTTO
TOP
UNDER
MOUNT
- 
FILO
TOP
FLUSH
MOUNT
- 
SOPRA
TOP
INSET



***_Dual Mount - Diverse
modalità di montaggio per
la massima espressione stilistica.***

**Diverse possibilità
di installazione come valore
aggiunto della personalizzazione
dell'area lavoro che segue
e prosegue le linee estetiche
pure, uniformando lavello
e top cucina.**

*_Dual-mount - different
mounting options for
maximum stylistic expression.*

Different installation
possibilities are available to
provide added value when
customising the work area,
following and continuing
the pure aesthetic lines
to create a uniform sink
and worktop.

FILO TOP_ FLUSHMOUNT



SOPRA TOP_ INSET



PRODUCT LINES.

BEST



SINTESI



GAMMA
PRODOTTI.

ZEN

DIALOGO



DIALOGO



reddot winner 2021
best of the best



DESIGN
AWARD
2021

Dialogo 360 Workstation | Dialogo C86 Equipped Track K82 Sage Green | Flux BK Black

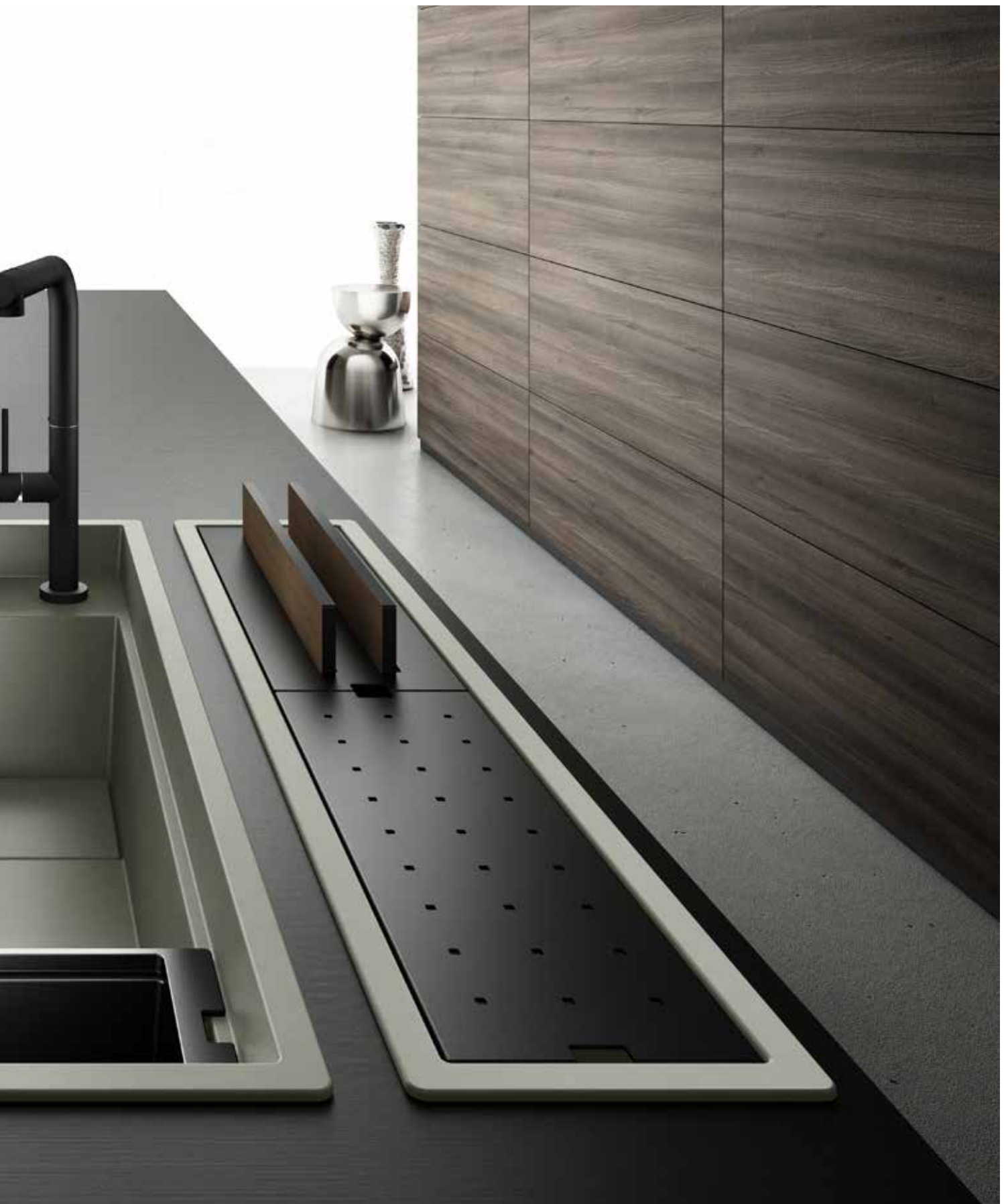

DIALOGO

L'intuizione è un lampo di genio. L'estetica razionale del Dialogo permette di sfruttare al massimo il volume della vasca extralarge in modo intelligente ed estremamente razionale; il pianale ad inclinazione maggiorata favorisce il miglior deflusso dell'acqua. Profondità, capienza e funzionalità al servizio del comfort.

Intuition is a flash of genius. The rational aesthetic of Dialogo makes the most of the extra-large bowl volume in a way that is both intelligent and extremely functional. The increased grade of the flat surface improves water discharge. Depth, capacity and functionality designed to provide greater well-being.

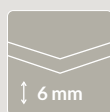

SMART EDGE



SLIDING ACCESSORIES

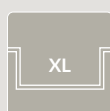

EXTRA-LARGE BOWL



SOPRA TOP INSET



SOTTO TOP UNDERMOUNT



reddot winner 2021
best of the best



DIALOGO



Dialogo 360 Workstation | Dialogo C86 Equipped Track K83 Clay | Wave BK Black



reddot winner 2021
best of the best



DIALOGO

Stile e tendenza a portata di mano. Con Dialogo tutti gli elementi collaborano con la massima interazione per un lifestyle semplificato e contemporaneo grazie al canale attrezzato; vero protagonista della gamma. Design e funzionalità non sono mai stati così spontanei.

Style and trend at fingertips. With Dialogo, all the elements work together, providing maximum interaction to create a simplified, contemporary lifestyle thanks to the equipped track, the true centrepiece of the range. Design and functionality have never been so spontaneous.

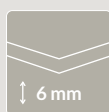

SMART EDGE

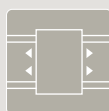

SLIDING
ACCESSORIES



EXTRA-LARGE
BOWL



SOPRA TOP
INSET



SOTTO TOP
UNDERMOUNT



Dialogo C86 Equipped Track K83 Clay

DIALOGO



Dialogo 360 Workstation K86 Black | Fold BK Black



reddot winner 2021
best of the best



DIALOGO

SINKS



SOPRA
TOP
INSET

SOTTO
TOP
UNDER
MOUNT

CORREDO
SINK KIT

Sifone salvaspazio, piletta Flow Pro, Overflow rettangolare e sistemi di fissaggio. Space-saving siphon, Flow Pro waste, rectangular overflow and fixing systems.

COMPONENTI
COMPONENTS

OVERFLOW

FLOW PRO

FINITURE
FINISHES

BKM - BLACK



reddot winner 2021
best of the best



DIALOGO 360 WORSTATION

Lavello 1 vasca
1-bowl sink

DIMENSIONI_DIMENSIONS
860 x 460 mm

PROFONDITÀ_VASCA_BOWL DEPTH
220 mm

BASE_BASE
900 mm

INCASSO_BUILT-IN:
SOPRATOP_INSET
850 x 450 R5 mm

SOTTOTOP_UNDERMOUNT
820 x 420 R4 mm

DUAL MOUNTED
REVERSIBILE_REVERSIBLE

KERATEK plus
CERAMIC NANOTECHNOLOGY CNB

CODICE
CODE

	K86 BLACK	LKD36086BKM
	K97 LIGHT GREY	LKD36097BKM
	K96 WHITE	LKD36096BKM
	K82 SAGE GREEN	LKD36082BKM
	K83 CAVERN CLAY	LKD36083BKM

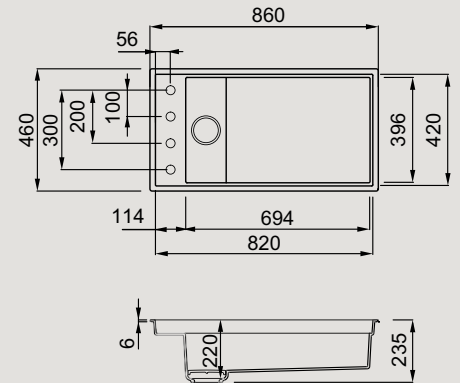

reddot winner 2021
best of the best



DIALOGO C86 CANALE ATTREZZATO

Lavello accessorio 1 vasca
1-bowl accessory sink

DIMENSIONI_DIMENSIONS
860 x 180 mm

PROFONDITÀ_VASCA_BOWL DEPTH
150 mm

BASE_BASE
900 mm

INCASSO_BUILT-IN:
SOPRATOP_INSET
850 x 170 R5 mm

SOTTOTOP_UNDERMOUNT
820 x 140 R4 mm

DUAL MOUNTED
REVERSIBILE_REVERSIBLE

KERATEK plus
CERAMIC NANOTECHNOLOGY CNB

CODICE
CODE

	K86 BLACK	LKDC8686BKM
	K97 LIGHT GREY	LKDC8697BKM
	K96 WHITE	LKDC8696BKM
	K82 SAGE GREEN	LKDC8682BKM
	K83 CAVERN CLAY	LKDC8683BKM

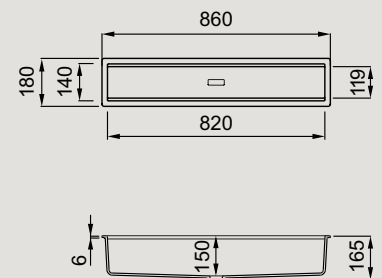

CORREDO
TRACK KIT

Elemento di raccordo allo scarico principale.
Connection element to the main drain.

DIALOGO

ACCESSORIES

FINITURE FINISHES

- IN - INOX
- BK - BLACK
- WD - WOOD
- GD - GOLD

elleci | LAB



ELEMENT HALF TRAY

Base multitasking in alluminio
Aluminium multitasking base



ELEMENT TRAY

Base multitasking in alluminio
Aluminium multitasking base

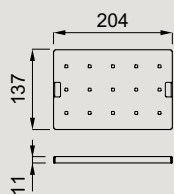

AMA053BK

DIMENSIONI DIMENSIONS
204 x 137 x 11 mm

COMPATIBILE CON COMPATIBLE WITH
DIALOGO C86 CANALE ATTREZZATO

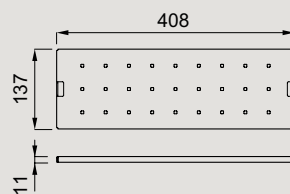

AMA103BK

DIMENSIONI DIMENSIONS
408 x 137 x 11 mm

COMPATIBILE CON COMPATIBLE WITH
DIALOGO 360 WORKSTATION
DIALOGO C86 CANALE
ATTREZZATO



ELEMENT KIT 2 PORTATAGLIERI

ELEMENT KIT 2 CUTTING BOARDS

Struttura portatagliere in alluminio
e taglieri in HPL

Aluminium chopping board rack
and HPL chopping boards



ELEMENT DRAINER FLEX 440

Drainer Flex in silicone con
barre in acciaio rivestite

Silicone Flex drainer with
steel-coated bars

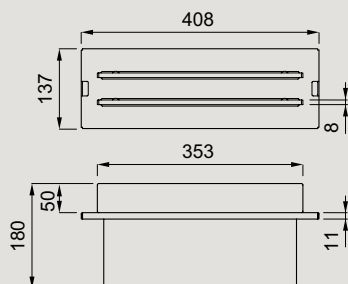

KTA001BK



KTA001WD

DIMENSIONI DIMENSIONS
408 x 137 x 180 mm

COMPATIBILE CON COMPATIBLE WITH
DIALOGO 360 WORKSTATION
DIALOGO C86 CANALE ATTREZZATO

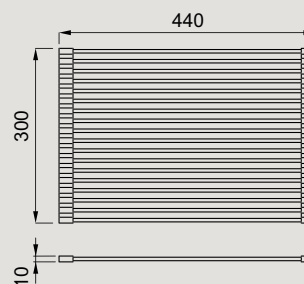

ARS013BK

DIMENSIONI DIMENSIONS
440 x 300 x 10 mm

COMPATIBILE CON COMPATIBLE WITH
DIALOGO 360 WORKSTATION

DIALOGO

ACCESSORIES

FINITURE FINISHES

- IN - INOX
- BK - BLACK
- WD - WOOD
- GD - GOLD



ELEMENT DIALOGO COLANDER

Colander in Polipropilene
Polypropylene Colander

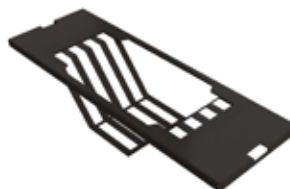

ELEMENT DRAINER

Scolapiatti in alluminio
Aluminium dish drainer

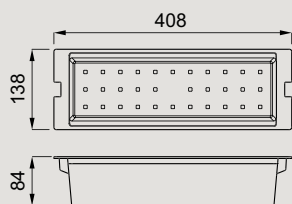

AVP033BK

DIMENSIONI DIMENSIONS
408 x 138 x 84 mm

COMPATIBILE CON COMPATIBLE WITH
DIALOGO 360 WORKSTATION
DIALOGO C86 CANALE ATTREZZATO

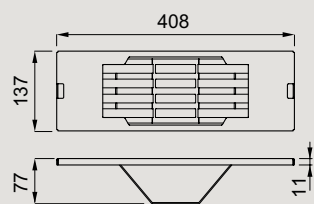

ADA103BK

DIMENSIONI DIMENSIONS
408 x 137 x 77 mm

COMPATIBILE CON COMPATIBLE WITH
DIALOGO 360 WORKSTATION
DIALOGO C86 CANALE ATTREZZATO



GOURMET KIT DIALOGO FRAME 1/3

Frame in HPL e vaschetta in acciaio inox
HPL Frame and stainless steel tray



GOURMET KIT DIALOGO FRAME 1/6

Frame in HPL e vaschette in acciaio inox
HPL Frame and stainless steel trays

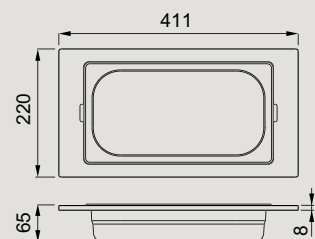

KF021065IN



KF021065BK



KF021065GD

DIMENSIONI DIMENSIONS
411 x 220 x 65 mm

COMPATIBILE CON COMPATIBLE WITH
DIALOGO 360 WORKSTATION

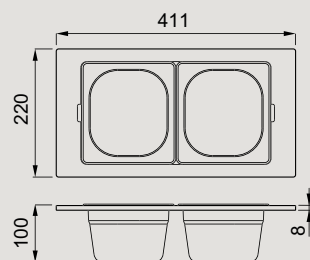

KF022100IN



KF022100BK



KF022100GD

DIMENSIONI DIMENSIONS
411 x 220 x 100 mm

COMPATIBILE CON COMPATIBLE WITH
DIALOGO 360 WORKSTATION

OPEN UP



FLOW PRO



DIMENSIONE FORO DI INCASSO
DIMENSIONS OF HOLE FOR BUILT-IN INSTALLATION
Ø 35

DIMENSIONE DIMENSION
Ø 114

ELEMENT KIT OPEN UP PUSH-CONTROL

Sistema di scarico 1 via Flow Pro con comando remoto Open up
1-way automatic Flow Pro drainer system with Open Up remote control



ASP13004BK

COMPATIBILE CON COMPATIBLE WITH
DIALOGO 360 WORKSTATION



SOAP DISPENSER



ADI02300BK

COMPATIBILE CON COMPATIBLE WITH
DIALOGO 360 WORKSTATION

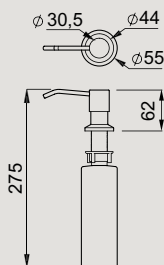

GOURMET KIT DIALOGO FRAME 1/9

Frame in HPL e vaschette in acciaio inox
HPL Frame and stainless steel trays



KF023100IN



KF023100BK



KF023100GD

DIMENSIONI DIMENSIONS
411 x 220 x 100 mm

COMPATIBILE CON COMPATIBLE WITH
DIALOGO 360 WORKSTATION

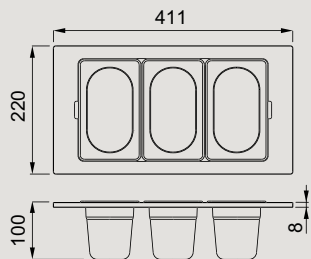

POSSIBILI CONFIGURAZIONI

POSSIBLE CONFIGURATIONS



SINTESI



Sintesi 130 K82 Sage Green | Loop GD Gold

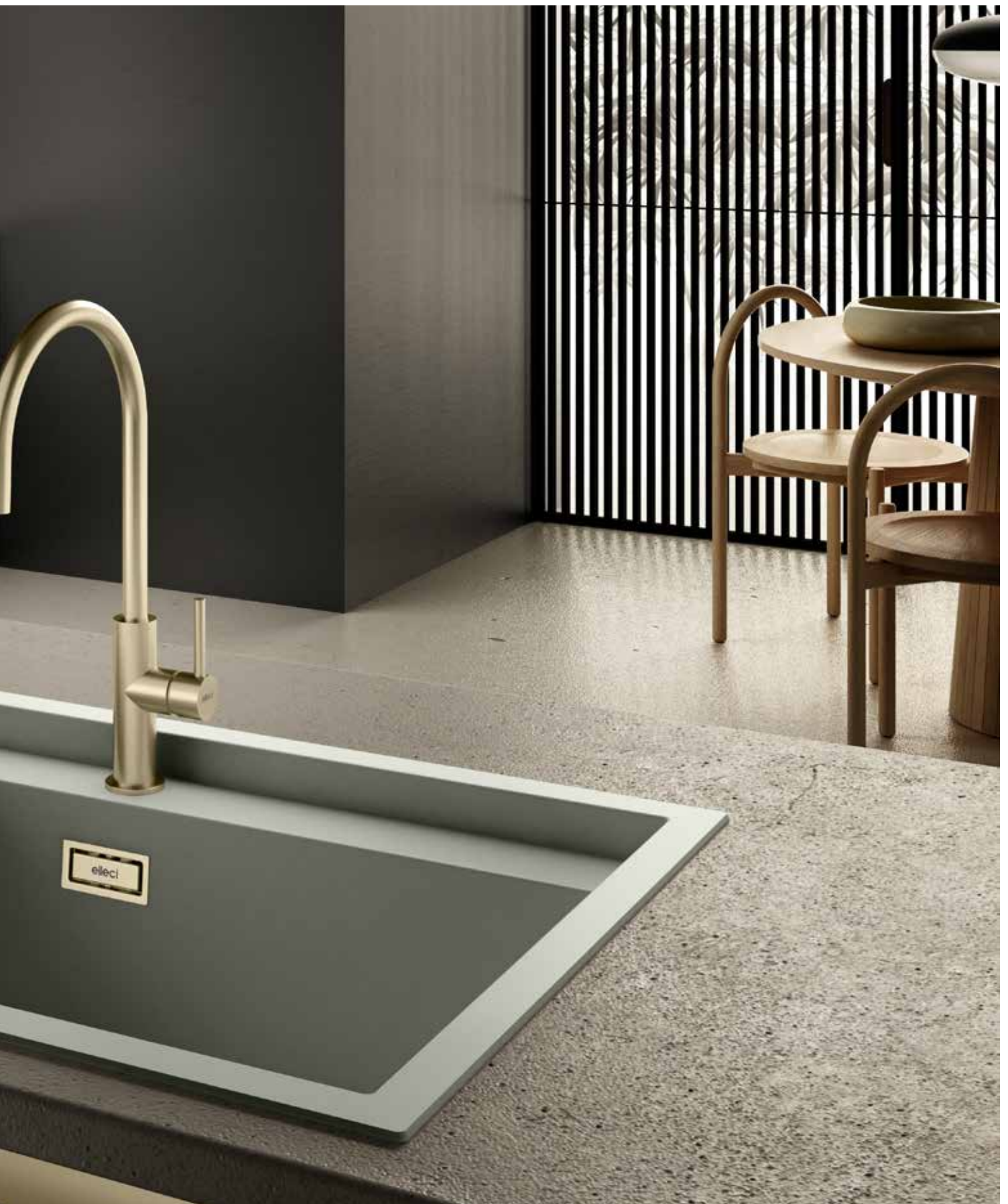

SINTESI

L'eleganza di una sensibilità estetica raffinata si unisce alla funzionalità, anticipando i bisogni di domani. Dalla ricerca applicata all'ergonomia: un prodotto caratterizzato dalla vasca singola extra capiente e gocciolatoio strategico come estensione e cuore pulsante dell'intera working area.

The elegance of a refined aesthetic sensibility married with functionality, anticipating the needs of tomorrow. From applied research to ergonomics: a product characterised by the extra-large single bowl and strategic drainer as an extension and central focus of the entire working area.



SMART EDGE

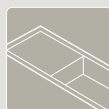

MULTI FUNCTIONAL DRAINER



EXTRA-LARGE BOWL



SOPRA TOP INSET



FILO TOP FLUSHMOUNT



Sintesi 130 K82 Sage Green | Loop GD Gold

SINTESI



red dot winner 2022



Sintesi 510 K97 Light Grey | Flux BK Black



SINTESI

La classe non è acqua. Un piano di lavoro amplificato si completa di gocciolatoio sfruttando le leggi fisiche per comunicare con l'acqua. Linee minimaliste ed essenziali per un'estetica rinnovata e moderna.

Style will out. An extended worktop finished with a drainer, exploiting the laws of physics to channel water more efficiently. Essential, minimalist lines provide a renewed, modern aesthetic.

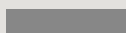

SMART EDGE

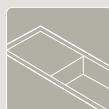

MULTI FUNCTIONAL DRAINER



EXTRA-LARGE BOWL



SOPRA TOP INSET



FILO TOP FLUSHMOUNT

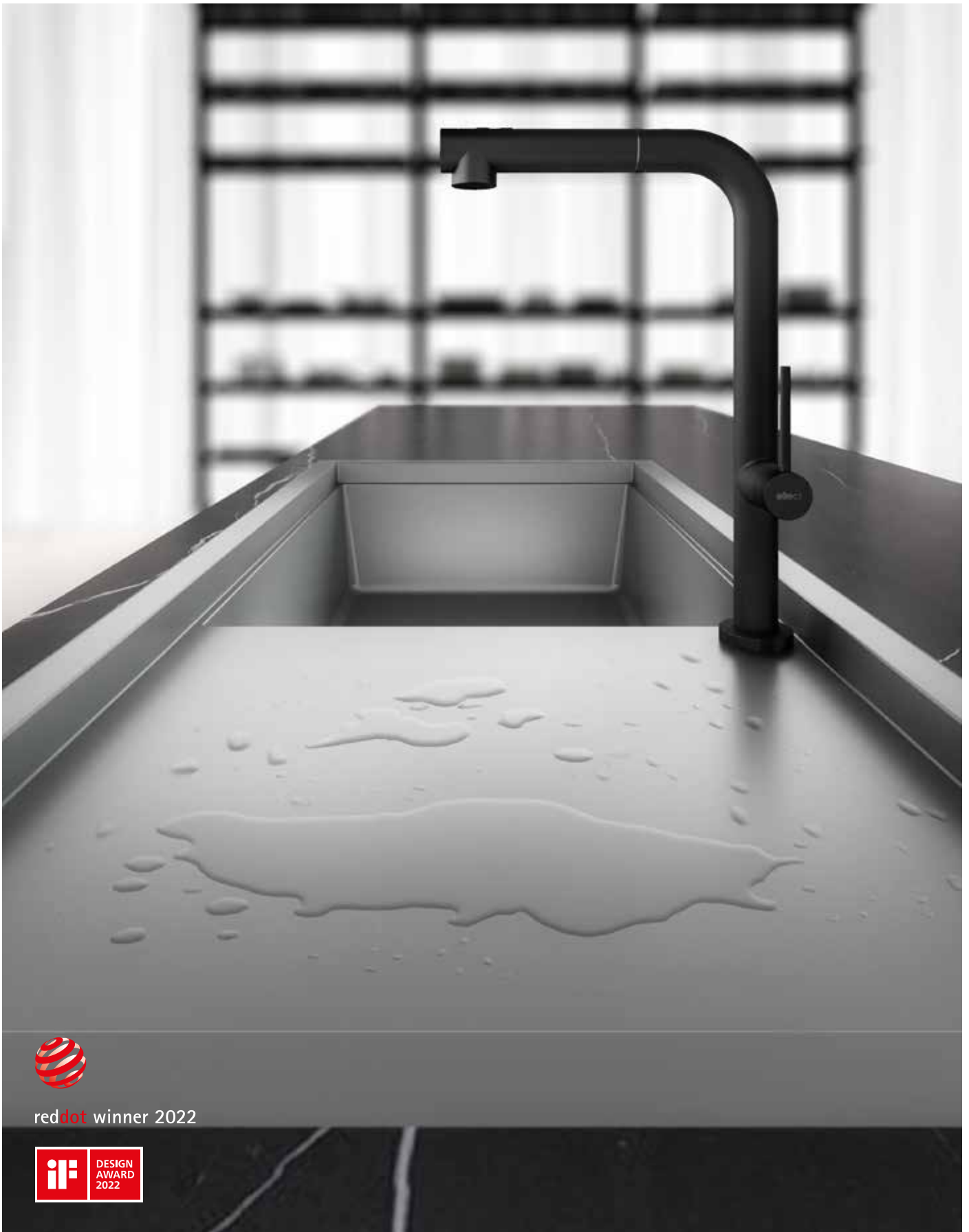

red dot winner 2022



SINTESI

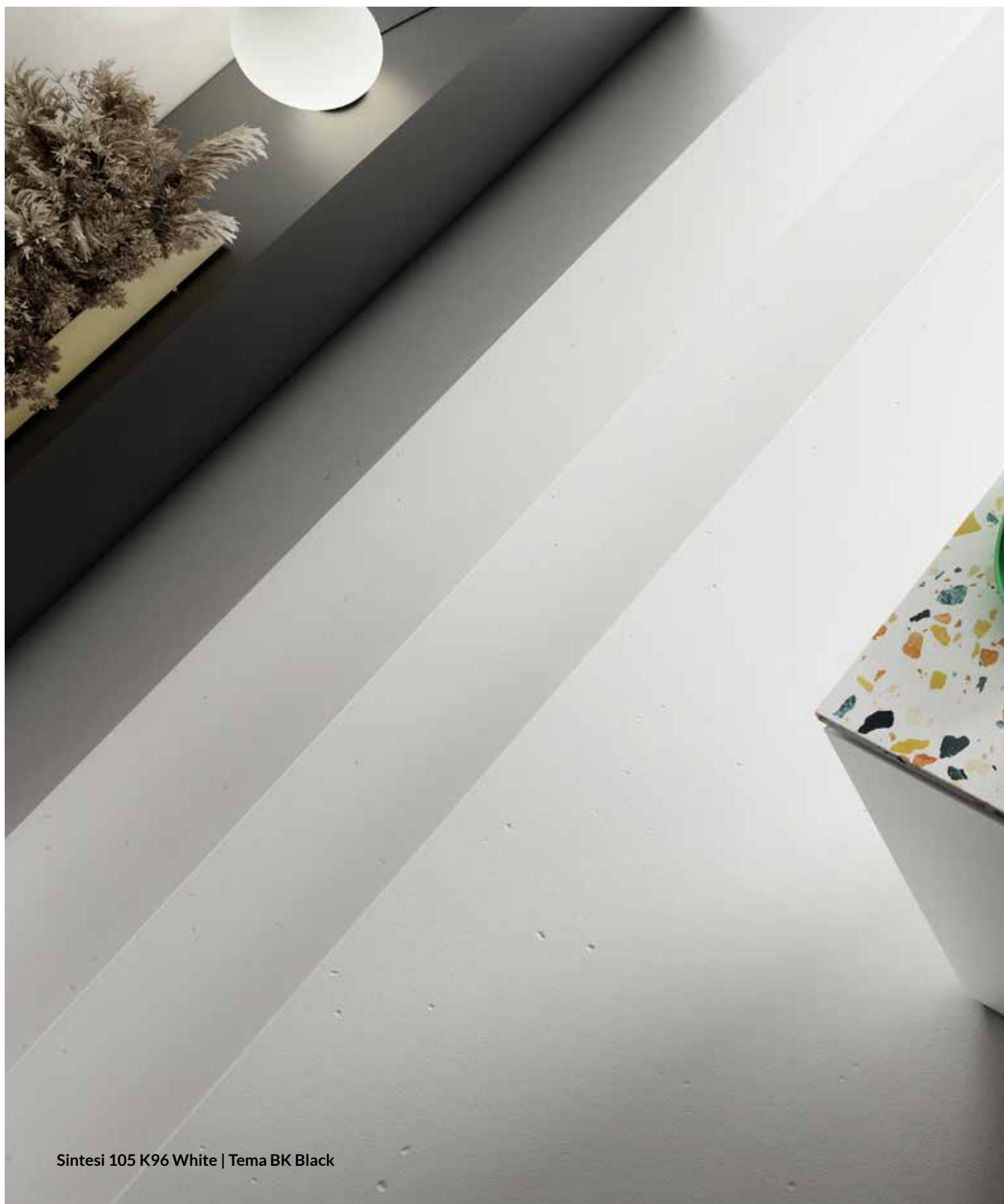

Sintesi 105 K96 White | Tema BK Black



SINTESI

Una soluzione per tutti gli spazi. La vasca singola, presente in diversi ingombri, garantisce la massima efficienza anche per le cucine più contenute.

A solution for all spaces. The single bowl is available in different dimensions, guaranteeing maximum efficiency for even the smallest kitchens.



SMART EDGE

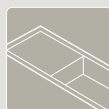

MULTI FUNCTIONAL DRAINER



EXTRA-LARGE BOWL



SOPRA TOP INSET



FILO TOP FLUSHMOUNT



Sintesi 105 K96 White | Tema BK Black

SINTESI SINKS



SOPRA TOP INSET
FILO TOP FLUSH MOUNT

CORREDO
SINK KIT

Sifone salvaspazio, piletta Flow Pro, Overflow rettangolare e sistemi di fissaggio.
Space-saving siphon, Flow Pro waste, rectangular overflow and fixing systems.

COMPONENTI
COMPONENTS



FINITURE
FINISHES

● BKM - BLACK
● GLD - GOLD
● IN - INOX



reddot winner 2022



SINTESI 510

Lavello 1 vasca con gocciolatoio
1-bowl sink with drainer

DIMENSIONI_DIMENSIONS
1160 x 500 mm

PROFONDITÀ VASCA_BOWL DEPTH
200 mm

BASE_BASE I mm TOP I mm TOP
800 mm ≥ 35 ≥ 40
1200 mm < 35 < 40

INCASSO_BUILT-IN:
SOPRATOP_INSET
1140 x 480 mm

FILOTOP_FLUSHMOUNT I min 20 mm
da disegno_as per drawing

DUAL MOUNTED
REVERSIBILE_REVERSIBLE

KERATEK plus
CERAMIC NANOTECHNOLOGY CNB

COMPONENTI
COMPONENTS

CODICE
CODE

● K86
BLACK

● BKM
● GLD
● INOX

LKS51086BKM
LKS51086GLD
LKS51086

● K97
LIGHT GREY

● BKM
● GLD
● INOX

LKS51097BKM
LKS51097GLD
LKS51097

● K96
WHITE

● BKM
● GLD
● INOX

LKS51096BKM
LKS51096GLD
LKS51096

● K82
SAGE GREEN

● BKM
● GLD
● INOX

LKS51082BKM
LKS51082GLD
LKS51082

● K83
CAVERN CLAY

● BKM
● GLD
● INOX

LKS51083BKM
LKS51083GLD
LKS51083

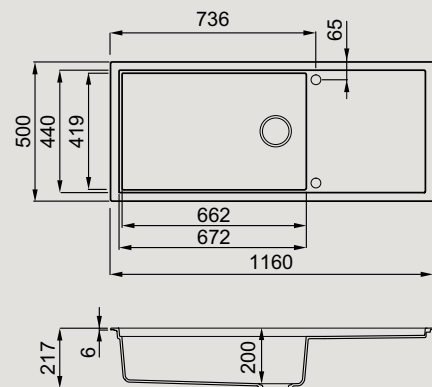

SINTESI 480

Lavello 1 vasca con gocciolatoio
1-bowl sink with drainer

DIMENSIONI_DIMENSIONS
1000 x 500 mm

PROFONDITÀ VASCA_BOWL DEPTH
200 mm

BASE_BASE I mm TOP I mm TOP
600 mm ≥ 35 ≥ 40
1200 mm < 35 < 40

INCASSO_BUILT-IN:
SOPRATOP_INSET
980 x 480 mm

FILOTOP_FLUSHMOUNT I min 20 mm
da disegno_as per drawing

DUAL MOUNTED
REVERSIBILE_REVERSIBLE

KERATEK plus
CERAMIC NANOTECHNOLOGY CNB

COMPONENTI
COMPONENTS

CODICE
CODE

● K86
BLACK

● BKM
● GLD
● INOX

LKS48086BKM
LKS48086GLD
LKS48086

● K97
LIGHT GREY

● BKM
● GLD
● INOX

LKS48097BKM
LKS48097GLD
LKS48097

● K96
WHITE

● BKM
● GLD
● INOX

LKS48096BKM
LKS48096GLD
LKS48096

● K82
SAGE GREEN

● BKM
● GLD
● INOX

LKS48082BKM
LKS48082GLD
LKS48082

● K83
CAVERN CLAY

● BKM
● GLD
● INOX

LKS48083BKM
LKS48083GLD
LKS48083

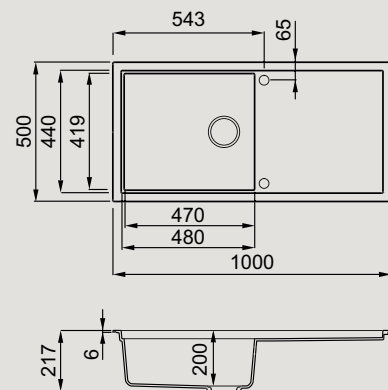



SINTESI 410

Lavello 1 vasca con gocciolatoio
1-bowl sink with drainer

DIMENSIONI_DIMENSIONS
860 x 500 mm

PROFONDITÀ_VASCA_BOWL DEPTH
200 mm

BASE_BASE mm TOP mm TOP
600 mm ≥ 35 ≥ 40
900 mm < 35 < 40

INCASSO_BUILT-IN:
SOPRATOP_INSET
840 x 480 mm

FILOTOP_FLUSHMOUNT min 20 mm
da disegno.as per drawing

DUAL MOUNTED
REVERSIBILE_REVERSIBLE

KERATEK plus
CERAMIC NANOTECHNOLOGY CNB

COMPONENTI
COMPONENTS

CODICE
CODE

	K86	● BKM	LKS41086BKM
	BLACK	● GLD	LKS41086GLD
		● INOX	LKS41086
	K97	● BKM	LKS41097BKM
	LIGHT	● GLD	LKS41097GLD
	GREY	● INOX	LKS41097
	K96	● BKM	LKS41096BKM
	WHITE	● GLD	LKS41096GLD
		● INOX	LKS41096
	K82	● BKM	LKS41082BKM
	SAGE	● GLD	LKS41082GLD
	GREEN	● INOX	LKS41082
	K83	● BKM	LKS41083BKM
	CAVERN	● GLD	LKS41083GLD
	CLAY	● INOX	LKS41083

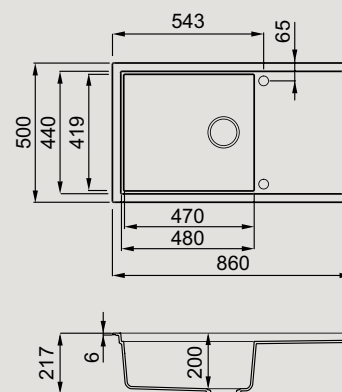

SINTESI

SINKS



SOPRA
TOP
INSET

FILO
TOP
FLUSH
MOUNT

CORREDO
SINK KIT

Sifone salvaspazio, piletta Flow Pro, Overflow rettangolare e sistemi di fissaggio.
Space-saving siphon, Flow Pro waste, rectangular overflow and fixing systems.

COMPONENTI
COMPONENTS

OVERFLOW

FLOW PRO

FINITURE
FINISHES

● **BKM - BLACK**
● **GLD - GOLD**
● **INOX**



SINTESI 130

Lavello 1 vasca
1-bowl sink

DIMENSIONI_DIMENSIONS
790 x 500 mm

PROFONDITÀ_VASCA_BOWL DEPTH
200 mm

BASE_BASE
800 mm

INCASSO_BUILT-IN:
SOPRATOP_INSET
770 x 480 mm

FILOTOP_FLUSHMOUNT min 20 mm
da disegno_as per drawing

DUAL MOUNTED
NON REVERSIBILE_NON-REVERSIBLE

KERATEK plus
CERAMIC NANOTECHNOLOGY CNB

COMPONENTI
COMPONENTS

CODICE
CODE



K86
BLACK



K97
LIGHT
GREY



K96
WHITE



K82
SAGE
GREEN



K83
CAVERN
CLAY

● **BKM**
● **GLD**
● **INOX**

LKS13086BKM
LKS13086GLD
LKS13086

● **BKM**
● **GLD**
● **INOX**

LKS13097BKM
LKS13097GLD
LKS13097

● **BKM**
● **GLD**
● **INOX**

LKS13096BKM
LKS13096GLD
LKS13096

● **BKM**
● **GLD**
● **INOX**

LKS13082BKM
LKS13082GLD
LKS13082

● **BKM**
● **GLD**
● **INOX**

LKS13083BKM
LKS13083GLD
LKS13083

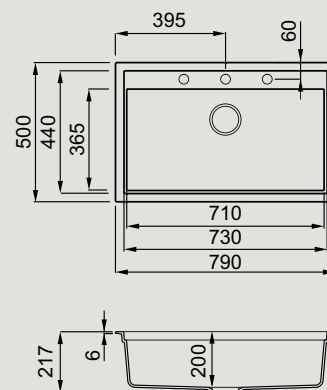

SINTESI 105

Lavello 1 vasca
1-bowl sink

DIMENSIONI_DIMENSIONS
570 x 500 mm

PROFONDITÀ_VASCA_BOWL DEPTH
200 mm

BASE_BASE
600 mm

INCASSO_BUILT-IN:
SOPRATOP_INSET
550 x 480 mm

FILOTOP_FLUSHMOUNT min 20 mm
da disegno_as per drawing

DUAL MOUNTED
NON REVERSIBILE_NON-REVERSIBLE

KERATEK plus
CERAMIC NANOTECHNOLOGY CNB

COMPONENTI
COMPONENTS

CODICE
CODE



K86
BLACK



K97
LIGHT
GREY



K96
WHITE



K82
SAGE
GREEN



K83
CAVERN
CLAY

● **BKM**
● **GLD**
● **INOX**

LKS10586BKM
LKS10586GLD
LKS10586

● **BKM**
● **GLD**
● **INOX**

LKS10597BKM
LKS10597GLD
LKS10597

● **BKM**
● **GLD**
● **INOX**

LKS10596BKM
LKS10596GLD
LKS10596

● **BKM**
● **GLD**
● **INOX**

LKS10582BKM
LKS10582GLD
LKS10582

● **BKM**
● **GLD**
● **INOX**

LKS10583BKM
LKS10583GLD
LKS10583

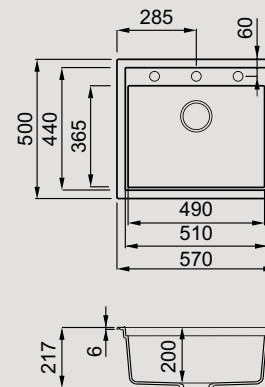

FINITURE
FINISHES

- IN - INOX
- BK - BLACK
- WD - WOOD
- GD - GOLD



TAGLIERE ELEMENT SINTESI DRAINER

ELEMENT SINTESI DRAINER CHOPPING BOARD

Tagliere multifunzione in HPL
Multifunction HPL Chopping Board



TAGLIERE ELEMENT 500 SINTESI

ELEMENT 500 SINTESI CHOPPING BOARD

Tagliere multifunzione in HPL
Multifunction HPL Chopping Board

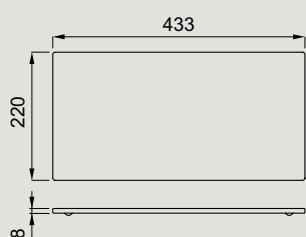

ATH103BK



ATH103WD

DIMENSIONI DIMENSIONS
433 x 220 x 8 mm

COMPATIBILE CON COMPATIBLE WITH
SINTESI 510, 480, 410

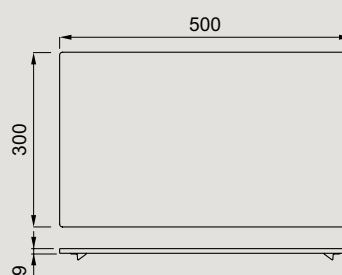

ATH093BK



ATH093WD

DIMENSIONI DIMENSIONS
500 x 300 x 9 mm

COMPATIBILE CON COMPATIBLE WITH
SINTESI 510, 480, 410, 130



TAGLIERE ELEMENT SINTESI BOWL

ELEMENT SINTESI BOWL CHOPPING BOARD

Tagliere multifunzione in HPL
Multifunction HPL Chopping Board

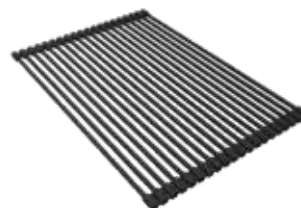

ELEMENT DRAINER FLEX 500

Drainer Flex in silicone con barre in acciaio rivestite

Silicone Flex drainer with steel-coated bars

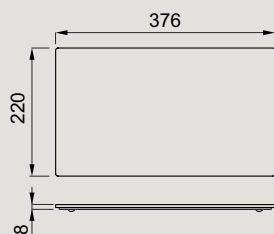

ATH113BK



ATH113WD

DIMENSIONI DIMENSIONS
376 x 220 x 8 mm

COMPATIBILE CON COMPATIBLE WITH
SINTESI 130, 105

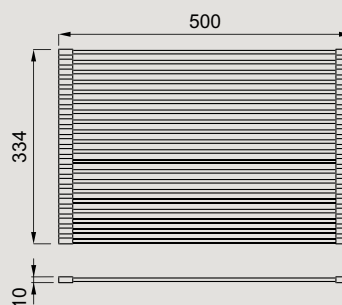

ARS023BK

DIMENSIONI DIMENSIONS
500 x 334 x 10 mm

COMPATIBILE CON COMPATIBLE WITH
SINTESI 510, 480, 410, 130

SINTESI

ACCESSORIES

FINITURE

FINISHES

- IN - INOX
- BK - BLACK
- WD - WOOD
- GD - GOLD



GOURMET KIT SINTESI DRAIN ON 1/3

Frame in HPL e vaschetta in acciaio inox
HPL Frame and stainless steel tray



GOURMET KIT SINTESI DRAIN ON 1/6

Frame in HPL e vaschette in acciaio inox
HPL Frame and stainless steel trays

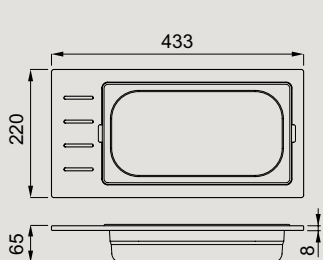

KD011065IN



KD011065BK



KD011065GD

DIMENSIONI DIMENSIONS
433 x 220 x 65 mm

COMPATIBILE CON COMPATIBLE WITH
SINTESI 510, 480, 410

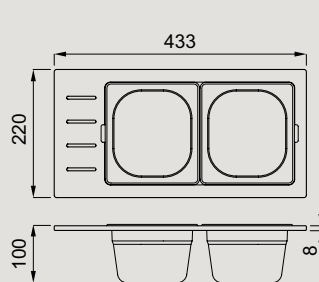

KD012100IN



KD012100BK



KD012100GD

DIMENSIONI DIMENSIONS
433 x 220 x 100 mm

COMPATIBILE CON COMPATIBLE WITH
SINTESI 510, 480, 410



GOURMET KIT SINTESI FRAME 1/3

Frame in HPL e vaschetta in acciaio inox
HPL Frame and stainless steel tray



GOURMET KIT SINTESI FRAME 1/6

Frame in HPL e vaschette in acciaio inox
HPL Frame and stainless steel trays

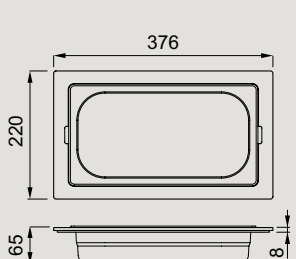

KF011065IN



KF011065BK



KF011065GD

DIMENSIONI DIMENSIONS
376 x 220 x 65 mm

COMPATIBILE CON COMPATIBLE WITH
SINTESI 130, 105

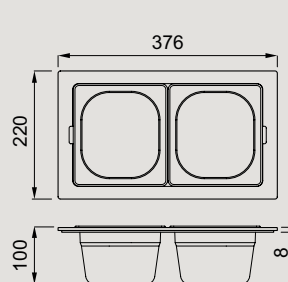

KF012100IN



KF012100BK



KF012100GD

DIMENSIONI DIMENSIONS
376 x 220 x 100 mm

COMPATIBILE CON COMPATIBLE WITH
SINTESI 130, 105

OPEN UP



FLOW PRO



DIMENSIONE FORO DI INCASSO DIMENSIONS OF HOLE FOR BUILT-IN INSTALLATION Ø 35

DIMENSIONE DIMENSION Ø 114

ELEMENT KIT OPEN UP PUSH-CONTROL

Sistema di scarico 1 via Flow Pro con comando remoto Open up 1-way automatic Flow Pro drainer system with Open Up remote control



ASP13004



ASP13004BK



ASP13004GD

COMPATIBILE CON COMPATIBLE WITH SINTESI 510, 480, 410, 130, 105



GOURMET KIT SINTESI DRAIN ON 1/9

Frame in HPL e vaschette in acciaio inox HPL Frame and stainless steel trays

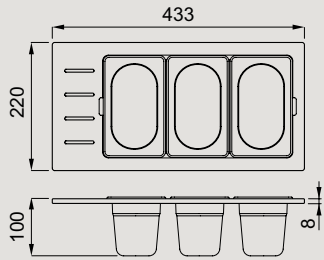

KD013100IN



KD013100BK



KD013100GD

DIMENSIONI DIMENSIONS 433 x 220 x 100 mm

COMPATIBILE CON COMPATIBLE WITH SINTESI 510, 480, 410



GOURMET KIT SINTESI FRAME 1/9

Frame in HPL e vaschette in acciaio inox HPL Frame and stainless steel trays

SOAP DISPENSER

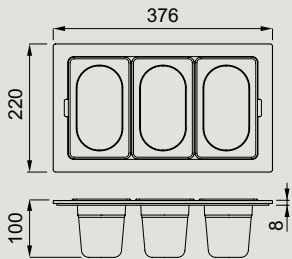

KF013100IN



KF013100BK



KF013100GD

DIMENSIONI DIMENSIONS 376 x 220 x 100 mm

COMPATIBILE CON COMPATIBLE WITH SINTESI 130, 105



ADI02300BK

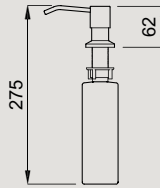
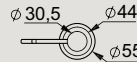

COMPATIBILE CON COMPATIBLE WITH 510, 480, 410, 130, 105

* non per installazione filotop * not for flushmount installation

POSSIBILI CONFIGURAZIONI

POSSIBLE CONFIGURATIONS



BEST workstation black edition



Best 360 Workstation Black Edition K86 Black | Wave BK Black



BEST workstation black edition

Keratek Plus black is the NEW BLACK. Un'edizione dalla colorazione profonda e contemporanea esalta la linea estetica della gamma Best Workstation. Caratterizzata dalla massima capienza della vasca suddivisa su tre livelli di lavoro; le geometrie collaborano per garantire la massima interazione nello spazio.

Keratek Plus black is the NEW BLACK. A new version in a deep, contemporary colour enhances the aesthetic line from the Best Workstation range. Characterised by the maximum capacity of the bowl divided into three different working levels – the geometric structures work together to guarantee maximum interaction within the space.



MULTI-LEVEL
ACCESSORIES



SLIDING
ACCESSORIES



EXTRA-LARGE
BOWL



SOPRA TOP
INSET



Best 360 Workstation Black Edition K86 Black | Wave BK Black

BEST workstation black edition



Best 360 Workstation Black Edition K86 Black | Stream Plus BK Black



BEST workstation black edition

In Best Workstation tutto lo spazio preparazione si presenta modulare: pregiati e rifiniti accessori, come le comode vaschette gastronorm, migliorano esponenzialmente l'esperienza in cucina traducendo in soluzioni d'uso quotidiano i bisogni più abituali.

With Best Workstation, all the preparation spaces are modular: beautiful, refined accessories, like the convenient gastronorm trays, exponentially improve the experience in the kitchen, transforming the most routine needs into solutions for everyday use.



MULTI-LEVEL
ACCESSORIES



SLIDING
ACCESSORIES



EXTRA-LARGE
BOWL



SOPRA TOP
INSET



Best 360 Workstation Black Edition K86 Black | Stream Plus BK Black

BEST

workstation black edition SINKS



CORREDO
SINK KIT

**SOPRA
TOP**
INSET

Sifone salvaspazio, piletta Flow Pro, Overflow rettangolare e sistemi di fissaggio.
Space-saving siphon, Flow Pro waste, rectangular overflow and fixing systems.

COMPONENTI
COMPONENTS

OVERFLOW

FLOW PRO

FINITURE
FINISHES

BKM - BLACK



BEST 360

Lavello 1 vasca
1-bowl sink

DIMENSIONI DIMENSIONS
860 x 510 mm

PROFONDITÀ VASCA BOWL DEPTH
200 mm

BASE BASE
900 mm

INCASSO BUILT-IN:
SOPRATOP INSET
840 x 480 mm

NON REVERSIBILE NON-REVERSIBLE

KERATEK plus CODICE
CERAMIC NANOTECHNOLOGY CNB CODE

K86
BLACK

LKB36086BKM

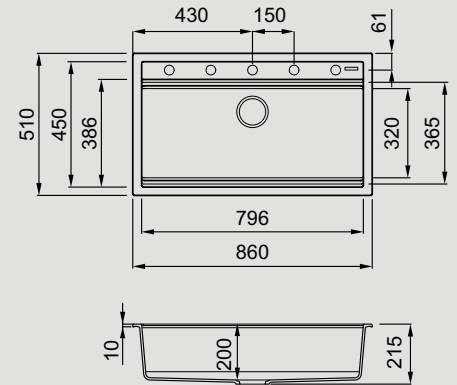

BEST 130

Lavello 1 vasca
1-bowl sink

DIMENSIONI DIMENSIONS
790 x 510 mm

PROFONDITÀ VASCA BOWL DEPTH
200 mm

BASE BASE
800 mm

INCASSO BUILT-IN:
SOPRATOP INSET
770 x 480 mm

NON REVERSIBILE NON-REVERSIBLE

KERATEK plus CODICE
CERAMIC NANOTECHNOLOGY CNB CODE

K86
BLACK

LKB13086BKM

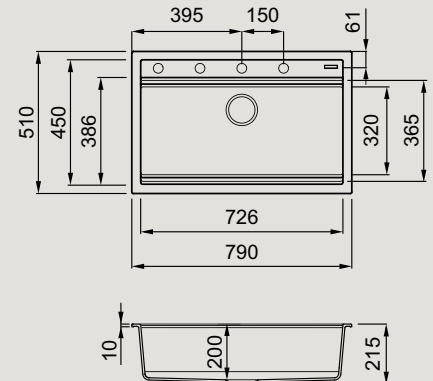



BEST 105

Lavello 1 vasca
1-bowl sink

DIMENSIONI_DIMENSIONS
570 x 510 mm

PROFONDITÀ VASCA_BOWL DEPTH
200 mm

BASE_BASE
600 mm

INCASSO_BUILT-IN:
SOPRATOP_INSET
550 x 480 mm

NON REVERSIBILE_NON-REVERSIBLE

KERATEK plus CODICE
CERAMIC NANOTECHNOLOGY CNB CODE



K86
BLACK

LKB10586BKM

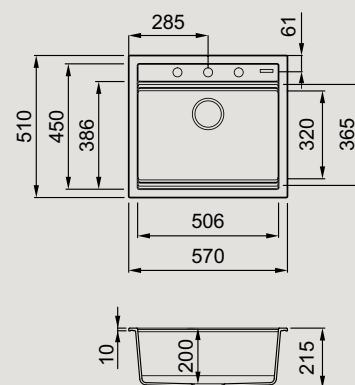

BEST 104

Lavello 1 vasca
1-bowl sink

DIMENSIONI_DIMENSIONS
510 x 510 mm

PROFONDITÀ VASCA_BOWL DEPTH
200 mm

BASE_BASE
500 mm
600 mm se inizio composizione
600 mm if first component

INCASSO_BUILT-IN:
SOPRATOP_INSET
490 x 480 mm

NON REVERSIBILE_NON-REVERSIBLE

KERATEK plus CODICE
CERAMIC NANOTECHNOLOGY CNB CODE



K86
BLACK

LKB10486BKM

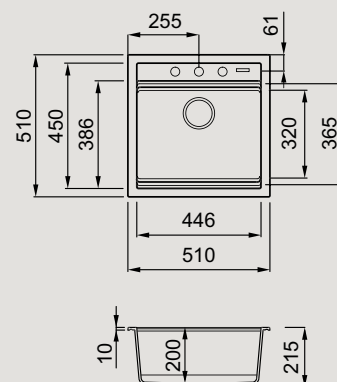

BEST

workstation black edition

ACCESSORIES

**FINITURE
FINISHES**

- IN - INOX
- BK - BLACK
- WD - WOOD
- GD - GOLD



ELEMENT BEST WORKSTATION COLANDER

Colander in Polipropilene
Polypropylene Colander



TAGLIERE ELEMENT BEST WORKSTATION

ELEMENT
BEST WORKSTATION
CHOPPING BOARD

Tagliere multifunzione in HPL
Multifunction HPL Chopping Board

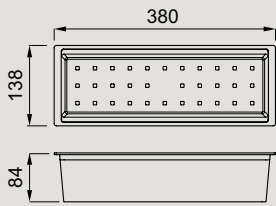

AVP034BK

DIMENSIONI DIMENSIONS
380 x 138 x 84 mm

COMPATIBILE CON COMPATIBLE WITH
BEST 360, 130, 105, 104

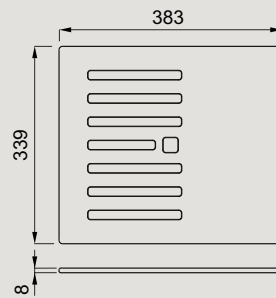

ATH073BK



ATH073WD

DIMENSIONI DIMENSIONS
383 x 339 x 8 mm

COMPATIBILE CON COMPATIBLE WITH
BEST 360, 130, 105, 104



GOURMET KIT BEST FRAME 1/3

Frame in HPL e vaschetta in acciaio inox
HPL Frame and stainless steel tray



GOURMET KIT BEST FRAME 1/6

Frame in HPL e vaschette in acciaio inox
HPL Frame and stainless steel trays

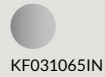
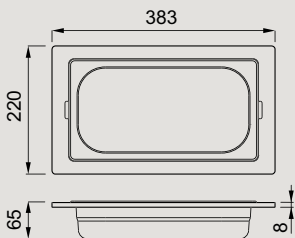

KF031065IN



KF031065BK



KF031065GD

DIMENSIONI DIMENSIONS
383 x 220 x 65 mm

COMPATIBILE CON COMPATIBLE WITH
BEST 360, 130, 105, 104

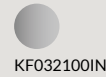
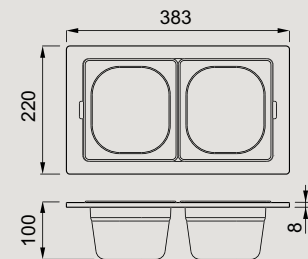

KF032100IN



KF032100BK



KF032100GD

DIMENSIONI DIMENSIONS
383 x 220 x 100 mm

COMPATIBILE CON COMPATIBLE WITH
BEST 360, 130, 105, 104

OPEN UP



FLOW PRO



DIMENSIONE FORO DI INCASSO
DIMENSIONS OF HOLE FOR BUILT-IN INSTALLATION
Ø 35

DIMENSIONE
DIMENSION
Ø 114

ELEMENT KIT OPEN UP PUSH-CONTROL

Sistema di scarico 1 via Flow Pro con comando remoto Open up
1-way automatic Flow Pro drainer system with Open Up remote control



ASP13004BK

COMPATIBILE CON COMPATIBLE WITH
BEST 360, 130, 105, 104

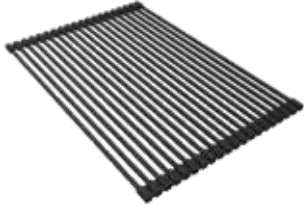

ELEMENT DRAINER FLEX 500

Drainer Flex in silicone con
barre in acciaio rivestite

Silicone Flex drainer with
steel-coated bars



ARS023BK

DIMENSIONI DIMENSIONS
500 x 334 x 10 mm

COMPATIBILE CON COMPATIBLE WITH
BEST 360, 130

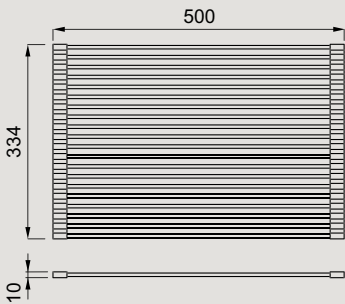

POSSIBILI CONFIGURAZIONI POSSIBLE CONFIGURATIONS



GOURMET KIT BEST FRAME 1/9

Frame in HPL e vaschette in acciaio inox
HPL Frame and stainless steel trays



KF033100IN



KF033100BK



KF033100GD

DIMENSIONI DIMENSIONS
383 x 220 x 100 mm

COMPATIBILE CON COMPATIBLE WITH
BEST 360, 130, 105, 104

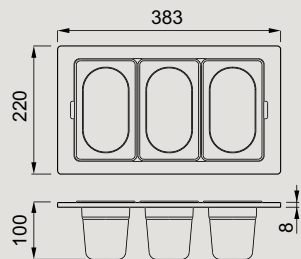

SOAP DISPENSER



ADI02300BK

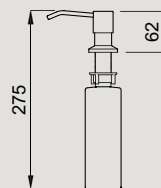
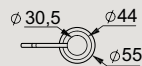

COMPATIBILE CON
COMPATIBLE WITH
BEST 360, 130,
105, 104



ZEN limited edition



Zen 130 Limited Edition K97 Light Grey | Loop BK Black



ZEN

limited edition

Quando il design è versatile e senza tempo si chiama Zen. Un nome che si fa garante di relax, precisione e pulizia.

When design is versatile and timeless it is called Zen. And that is a name that guarantees a relaxed, precise and clean aesthetic.

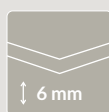
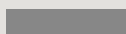

SMART EDGE

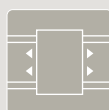

SLIDING ACCESSORIES



TIMELESS DESIGN



SOPRA TOP
INSET



SOTTO TOP
UNDERMOUNT



Zen 130 Limited Edition K97 Light Grey | Loop BK Black

ZEN F limited edition



Zen-F 130 Limited Edition K83 Cavern Clay | Loop BK Black

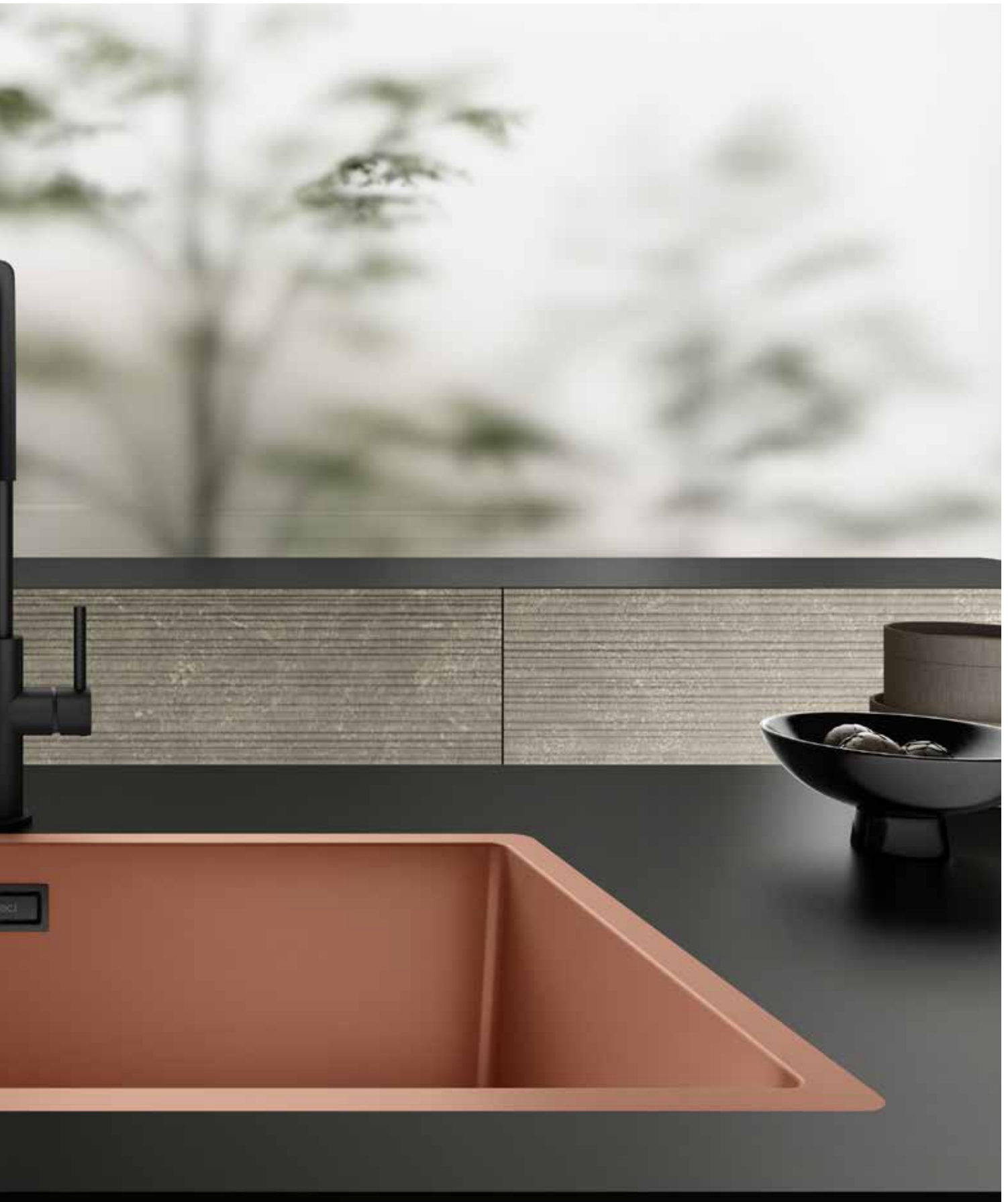

ZEN F

limited edition

L'estetica senza interruzioni. Linee e forme in continuum sensoriale. Zen F, la linea di lavelli con installazione filo top che esalta la fluidità tra piano e workstation.

Beauty without interruption. Lines and shapes in a sensory continuum. Zen F, the line of sinks with flushmount installation that enhances the fluidity between surface and workstation.

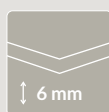
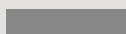

SMART EDGE



EDGELESS SHAPE



TIMELESS DESIGN



FILO TOP
FLUSHMOUNT

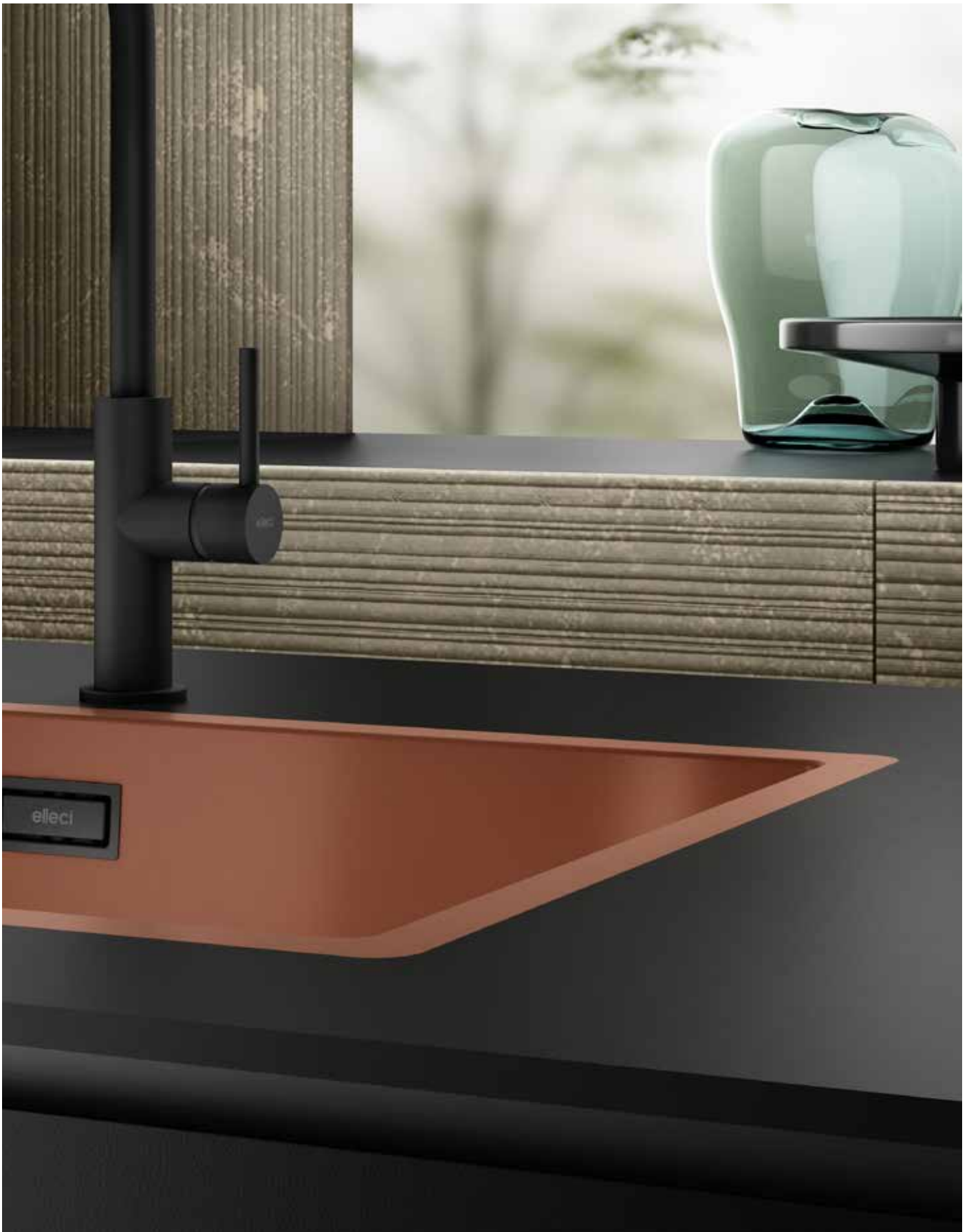

Zen-F 130 Limited Edition K83 Cavern Clay | Loop BK Black

ZEN

limited
edition
SINKS



SOPRA
TOP
INSET

SOTTO
TOP
SOTTO
TOP

CORREDO
SINK KIT

Sifone salvaspazio, piletta Flow Pro, Overflow rettangolare, sistemi di fissaggio.
Space-saving siphon, Flow Pro waste, rectangular overflow, fixing systems.

COMPONENTI
COMPONENTS

OVERFLOW

FLOW PRO

FINITURE
FINISHES

BKM - BLACK



ZEN 130

Lavello 1 vasca
1-bowl sink

DIMENSIONI DIMENSIONS
756 x 456 mm

PROFONDITÀ VASCA BOWL DEPTH
200 mm

BASE BASE
800 mm

INCASSO BUILT-IN:
SOPRATOP INSET
745 x 445 R5 mm

SOTTOTOP UNDERMOUNT
700 x 400 R10 mm

DUAL MOUNTED
NON REVERSIBILE NON-REVERSIBLE

KERATEK plus
CERAMIC NANOTECHNOLOGY CNB

CODICE
CODE

	K86 BLACK	LKZ13086BKM
	K97 LIGHT GREY	LKZ13097BKM
	K96 WHITE	LKZ13096BKM
	K82 SAGE GREEN	LKZ13082BKM
	K83 CAVERN CLAY	LKZ13083BKM

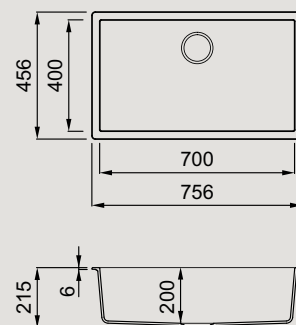

ZEN 105

Lavello 1 vasca
1-bowl sink

DIMENSIONI DIMENSIONS
556 x 456 mm

PROFONDITÀ VASCA BOWL DEPTH
200 mm

BASE BASE
600 mm

INCASSO BUILT-IN:
SOPRATOP INSET
545 x 445 R5 mm

SOTTOTOP UNDERMOUNT
500 x 400 R10 mm

DUAL MOUNTED
NON REVERSIBILE NON-REVERSIBLE

KERATEK plus
CERAMIC NANOTECHNOLOGY CNB

CODICE
CODE

	K86 BLACK	LKZ10586BKM
	K97 LIGHT GREY	LKZ10597BKM
	K96 WHITE	LKZ10596BKM
	K82 SAGE GREEN	LKZ10582BKM
	K83 CAVERN CLAY	LKZ10583BKM

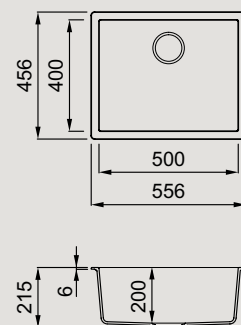



ZEN 102

Lavello 1 vasca
1-bowl sink

DIMENSIONI_DIMENSIONS
456 x 456 mm

PROFONDITÀ_VASCA_BOWL DEPTH
200 mm

BASE_BASE
SOPRATOP_INSET 450 mm
500 mm se inizio composizione
500 mm if first component
SOTTOTOP_UNDERMOUNT 500 mm

INCASSO_BUILT-IN:
SOPRATOP_INSET
445 x 445 R5 mm

SOTTOTOP_UNDERMOUNT
400 x 400 R10 mm

DUAL MOUNTED
NON REVERSIBILE_NON-REVERSIBLE

KERATEK plus
CERAMIC NANOTECHNOLOGY CNB

CODICE
CODE

	K86 BLACK	LKZ10286BKM
	K97 LIGHT GREY	LKZ10297BKM
	K96 WHITE	LKZ10296BKM
	K82 SAGE GREEN	LKZ10282BKM
	K83 CAVERN CLAY	LKZ10283BKM

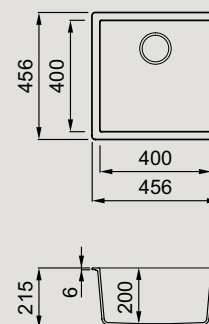

ZEN F

limited
edition
SINKS



CORREDO
SINK KIT

**FILO
TOP**
FLUSH
MOUNT

**Sifone salvaspazio, piletta Flow Pro,
Overflow rettangolare, sistemi di fissaggio.**
Space-saving siphon, Flow Pro waste,
rectangular overflow, fixing systems.

COMPONENTI
COMPONENTS

OVERFLOW

FLOW PRO

FINITURE
FINISHES

BKM - BLACK



ZEN F 130

Lavello 1 vasca
1-bowl sink

DIMENSIONI DIMENSIONS
748 x 448 mm

PROFONDITÀ VASCA BOWL DEPTH
200 mm

BASE BASE
800 mm

INCASSO BUILT-IN:
FILOTOP FLUSHMOUNT
da disegno as per drawing min 20 mm

NON REVERSIBILE NON-REVERSIBLE

KERATEK plus CODICE
CERAMIC NANOTECHNOLOGY CN8 CODE

	K86 BLACK	LKZ13086F01BKM
	K97 LIGHT GREY	LKZ13097F01BKM
	K96 WHITE	LKZ13096F01BKM
	K82 SAGE GREEN	LKZ13082F01BKM
	K83 CAVERN CLAY	LKZ13083F01BKM

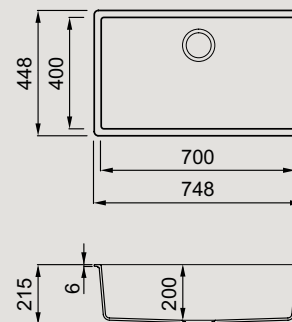

ZEN F 105

Lavello 1 vasca
1-bowl sink

DIMENSIONI DIMENSIONS
548 x 448 mm

PROFONDITÀ VASCA BOWL DEPTH
200 mm

BASE BASE
600 mm

INCASSO BUILT-IN:
FILOTOP FLUSHMOUNT
da disegno as per drawing min 20 mm

NON REVERSIBILE NON-REVERSIBLE

KERATEK plus CODICE
CERAMIC NANOTECHNOLOGY CN8 CODE

	K86 BLACK	LKZ10586F01BKM
	K97 LIGHT GREY	LKZ10597F01BKM
	K96 WHITE	LKZ10596F01BKM
	K82 SAGE GREEN	LKZ10582F01BKM
	K83 CAVERN CLAY	LKZ10583F01BKM

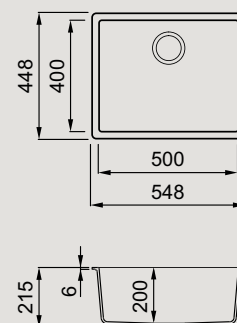



ZEN F 102

Lavello 1 vasca
1-bowl sink

DIMENSIONI_DIMENSIONS
448 x 448 mm

PROFONDITÀ_VASCA_BOWL DEPTH
200 mm

BASE_BASE
500 mm

INCASSO_BUILT-IN:
FILOTOP_FLUSHMOUNT
da disegno_as per drawing  min 20 mm

NON REVERSIBILE_NON-REVERSIBLE

KERATEK plus CERAMIC NANOTECHNOLOGY CN8 **CODICE**
CODE

	K86 BLACK	LKZ10286F01BKM
	K97 LIGHT GREY	LKZ10297F01BKM
	K96 WHITE	LKZ10296F01BKM
	K82 SAGE GREEN	LKZ10282F01BKM
	K83 CAVERN CLAY	LKZ10283F01BKM

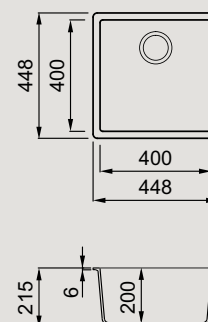

ZEN_ZEN F

limited edition

ACCESSORIES

FINITURE FINISHES

- IN - INOX
- BK - BLACK
- WD - WOOD
- GD - GOLD



ELEMENT ZEN COLANDER 418

Colander in Polipropilene
Polypropylene Colander



TAGLIERE ELEMENT 420

ELEMENT 420
CHOPPING BOARD

Tagliere multifunzione in HPL
Multifunction HPL Chopping Board

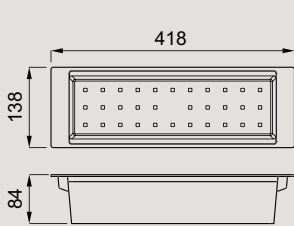

AVP035BK

DIMENSIONI DIMENSIONS
418 x 138 x 84 mm

COMPATIBILE CON COMPATIBLE WITH
ZEN_ZEN F 130, 105, 102

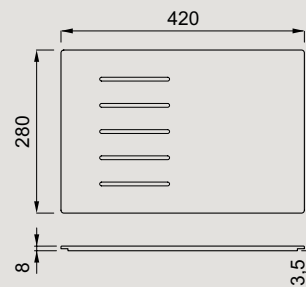

ATH040BK



ATH040WD

DIMENSIONI DIMENSIONS
420 x 280 x 8 mm

COMPATIBILE CON COMPATIBLE WITH
ZEN_ZEN F 130, 105, 102



GOURMET KIT ZEN_ZEN F FRAME 1/3

Frame in HPL e vaschetta in acciaio inox
HPL Frame and stainless steel tray



GOURMET KIT ZEN_ZEN F FRAME 1/6

Frame in HPL e vaschette in acciaio inox
HPL Frame and stainless steel trays

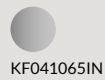
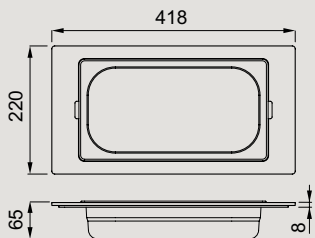

KF041065IN



KF041065BK



KF041065GD

DIMENSIONI DIMENSIONS
418 x 220 x 65 mm

COMPATIBILE CON COMPATIBLE WITH
ZEN_ZEN F 130, 105, 102

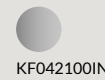
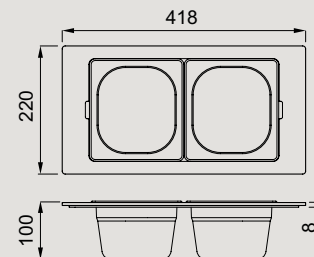

KF042100IN



KF042100BK



KF042100GD

DIMENSIONI DIMENSIONS
418 x 220 x 100 mm

COMPATIBILE CON COMPATIBLE WITH
ZEN_ZEN F 130, 105, 102

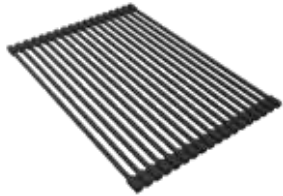

ELEMENT DRAINER FLEX 440

Drainer Flex in silicone con
barre in acciaio rivestite

Silicone Flex drainer with
steel-coated bars

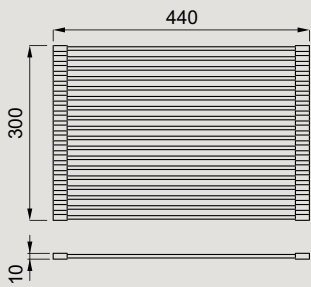

ARS013BK

DIMENSIONI DIMENSIONS
440 x 300 x 10 mm

COMPATIBILE CON COMPATIBLE WITH
ZEN_ZEN F 130, 105, 102



GOURMET KIT ZEN_ZEN F FRAME 1/9

Frame in HPL e vaschette in acciaio inox
HPL Frame and stainless steel trays

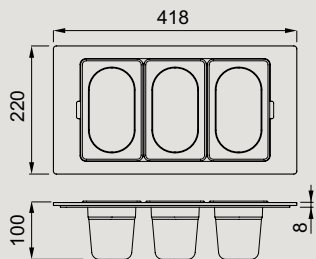

KF043100IN



KF043100BK



KF043100GD

DIMENSIONI DIMENSIONS
418 x 220 x 100 mm

COMPATIBILE CON COMPATIBLE WITH
ZEN_ZEN F 130, 105, 102

POSSIBILI CONFIGURAZIONI

POSSIBLE CONFIGURATIONS



KITCHEN TAPS

MISCELATORI

L'elegante involucro dell'acqua, dalle molteplici forme. Con numerose finiture e colorazioni disponibili, i nuovi miscelatori garantiscono la soddisfazione di ogni esigenza d'uso: forma, cambio getto e doccetta estraibile le varianti per il raggiungimento del comfort totale. Tecnica applicata all'ergonomia, con finiture raffinate che impreziosiscono l'intera area cucina.

An elegant vessel for water, in a range of shapes. Available in numerous finishes and colours, there is a new kitchen tap for every taste and requirement: shape, jet switch-over and pull-out sprayer variants make it possible to find just tap you want. Designed with a particular focus on aesthetics, this range reflects technical expertise applied to ergonomics, with refined finishes that elevate the entire kitchen.

Bellezza incisa.
Quando il dettaglio della lavorazione si imprime sulla superficie è per sempre.

Beauty built-in.
When the detail of the working is imprinted on the surface it lasts forever.

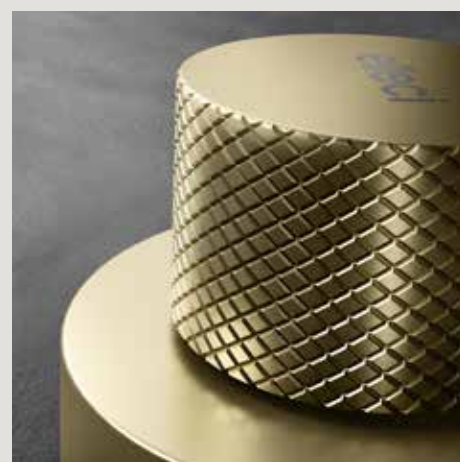

Fold GD Gold

Tutto il benessere di un flusso d'acqua soffice e regolare grazie ad un rompigetto disegnato per il massimo risparmio idrico.

All the comfort of a gentle, regular flow of water thanks to a tap aerator designed for maximum water saving.





Dialogo 360 K86 Black | Fold BK Black

KITCHEN TAPS

MISCELATORI

FOLD



Miscelatore abbattibile con canna girevole e comando remoto

Retractable tap with pull-out sprayer and remote control



MOKFOLBK



MOKFOLGD

DIMENSIONE FORO_HOLE SIZE
ø 35 mm

BASE_BASE
52 mm

ROTAZIONE CANNA_SPOUT ROTATION
360

FLESSIBILE_FLEXI-HOSE
Inox 3/8"

CARTUCCIA_CARTRIDGE
25 mm

BEST CHOICE
DIALOGO, SINTESI

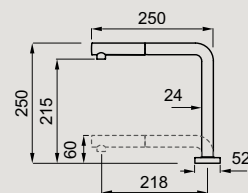

DOCCETTA
SPRAYER



ROTAZIONE CANNA
SPOUT ROTATION



ABBATTIBILE
RETRACTABLE



CAMBIO GETTO
JET SWITCH-OVER

WAVE



Miscelatore monocomando con canna alta girevole in silicone e doccetta estraibile

Single-lever tap with tall silicone swivel spout and pull-out sprayer



MOKWAVBK



MIKWAVCR

DIMENSIONE FORO_HOLE SIZE
ø 35 mm

BASE_BASE
50 mm

ROTAZIONE CANNA_SPOUT ROTATION
360

FLESSIBILE_FLEXI-HOSE
Inox 3/8"

CARTUCCIA_CARTRIDGE
25 mm

BEST CHOICE
BEST WORKSTATION, SINTESI

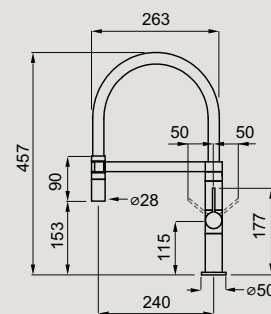

ROTAZIONE CANNA
SPOUT ROTATION



DOCCETTA
SPRAYER

FINITURE
FINISHES

- BK - BLACK
- GD - GOLD
- CR - CHROMIUM

LOOP



Miscelatore monocomando con canna girevole

Single-lever tap with swivel spout



MOKLOPBK



MOKLOPGD



MIKLOPCR

DIMENSIONE FORO_HOLE SIZE
ø 35 mm

BASE_BASE
48 mm

ROTAZIONE CANNA_SPOUT ROTATION
360

FLESSIBILE_FLEXI-HOSE
Inox 3/8"

CARTUCCIA_CARTRIDGE
35 mm

BEST CHOICE
ZEN, SINTESI

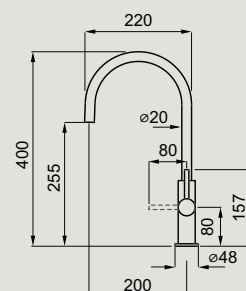

ROTAZIONE CANNA
SPOUT ROTATION



FUNZIONAMENTO
LEVA 0-90°
LEVER ROTATION 90°

TEMA



Miscelatore monocomando con canna girevole

Single-lever tap with swivel spout



MOKTEMBK



MIKTEMCR

DIMENSIONE FORO_HOLE SIZE
ø 35 mm

BASE_BASE
50 mm

ROTAZIONE CANNA_SPOUT ROTATION
360

FLESSIBILE_FLEXI-HOSE
Inox 3/8"

CARTUCCIA_CARTRIDGE
25 mm

BEST CHOICE
BEST WORKSTATION, SINTESI

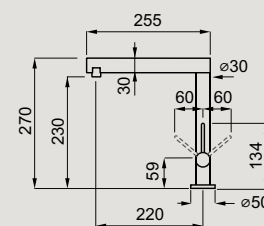

ROTAZIONE CANNA
SPOUT ROTATION

KITCHEN TAPS

MISCELATORI

FLUX



Miscelatore monocomando con canna girevole e doccetta con cambio getto

Single-lever tap with swivel spout and sprayer with jet switch-over



MOKFLUBK



MIKFLUCR

DIMENSIONE FORO_HOLE SIZE
ø 35 mm

BASE_BASE
50 mm

ROTAZIONE CANNA_SPOUT ROTATION
360

FLESSIBILE_FLEXI-HOSE
Inox 3/8"

CARTUCCIA_CARTRIDGE
25 mm

BEST CHOICE
SINTESI

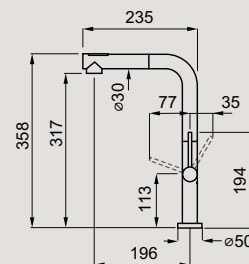

ROTAZIONE CANNA
SPOUT ROTATION



DOCCETTA
SPRAYER



CAMBIO GETTO
JET SWITCH-OVER

STREAM PLUS



Miscelatore monocomando con canna girevole e doccetta estraibile

Single-lever tap with swivel spout and pull-out sprayer



MOKSTPBK



MOKSTPGD



MIKSTPCR

DIMENSIONE FORO_HOLE SIZE
ø 35 mm

BASE_BASE
50 mm

ROTAZIONE CANNA_SPOUT ROTATION
360

FLESSIBILE_FLEXI-HOSE
Inox 3/8"

CARTUCCIA_CARTRIDGE
35 mm

BEST CHOICE
BEST WORKSTATION

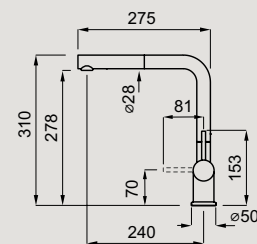

ROTAZIONE CANNA
SPOUT ROTATION



DOCCETTA
SPRAYER



FUNZIONAMENTO
LEVA 0-90°
LEVER ROTATION 90°

FINITURE
FINISHES

- BK - BLACK
- GD - GOLD
- CR - CHROMIUM

TRAIL



Miscelatore monocomando con canna girevole

Single-lever tap with swivel spout



MOKTRABK



MOKTRAGD

DIMENSIONE FORO_HOLE SIZE
ø 35 mm

BASE_BASE
50 mm

ROTAZIONE CANNA_SPOUT ROTATION
360

FLESSIBILE_FLEXI-HOSE
Inox 3/8"

CARTUCCIA_CARTRIDGE
35 mm

BEST CHOICE
SINTESI, DIALOGO

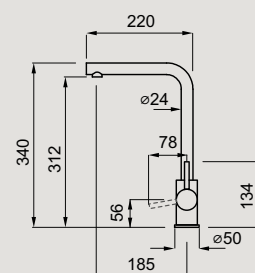

ROTAZIONE CANNA
SPOUT ROTATION



FUNZIONAMENTO
LEVA 0-90°
LEVER ROTATION 90°

COOKING HOBS

PIANI COTTURA

*Due diverse soluzioni, un solo spazio
in cui il design prende sapore.*

**Piano ad induzione o a gas
dalle linee precise, pure,
per emozioni di ultima generazione
su un piano di lavoro evoluto.**

*Two different solutions, a single
space where design creates flavour.*
Induction or gas hobs with precise,
pure lines – creating the ultimate
sensations and flavours on
the most advanced worktop.

LEAF 80 FLEX



SLIDE
COOKING



FLEX ZONE



STYLISH
DETAILS

PLANO PLUS 75



FLAT
BURNER



STEP
FLAME
CONTROL



DUAL
FUNCTION

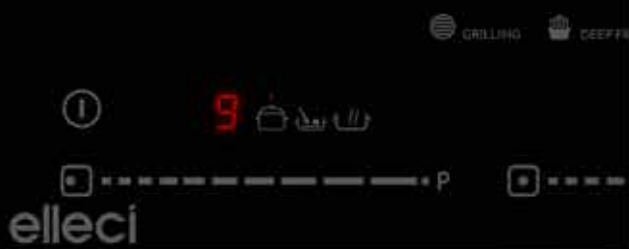

COOKING HOBS

PIANI COTTURA



IL DETTAGLIO DI DESIGN

Una cornice in alluminio impreziosisce il quadro cottura.

*Disponibile in finiture Alluminio, Black e Gold.

THE DETAIL OF DESIGN

An aluminium frame elevates the hob.

* Available in Aluminium, Black and Gold.



Induction LEAF 80 FLEX

SLIDE COOKING

L'arte di cucinare senza limiti. Una funzione di pura avanguardia permette di cambiare potenza semplicemente facendo scorrere la pentola sul piano cottura: tre diverse aree a potenza differenziata per gestualità fluide e misurate.

The art of cooking without limits. Pure cutting-edge function allows you to change power simply by sliding the pan across the hob: three different areas of differentiated power for smooth, measured movements.

FLEX FUNCTION

Tutto il calore che serve, solo dove serve. Il piano si riscalda unicamente nell'area di appoggio della pentola per una sicurezza assoluta ed un sostanzioso risparmio energetico.

All the heat you need, only where you need it. The hob heats up only in the area where the pan is positioned, guaranteeing absolute safety and substantial energy savings.



DESIGN DETAIL ALL - ALLUMINIUM_P1IL800AL

DESIGN DETAIL BK - BLACK_PGIL800BK

DESIGN DETAIL GLD - GOLD_PGIL800GD

Piano induzione in vetroceramica
Glass ceramic induction hob

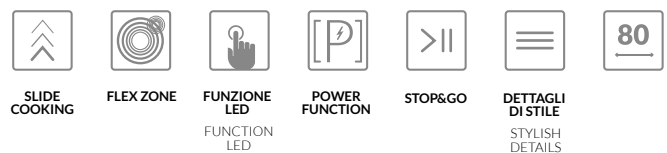

4 zone di cottura,
2 Zone (228x200mm); 1 Zona (Ø 280mm); 1 Zona (Ø 185mm)
Potenza massima assorbita 7200 W, SlideCooking, Touch Control,
Limitatore di potenza, Blocco di sicurezza bambini, Superficie in vetro ceramica.

4 induction cooking zones,
2 Zones (Ø 228x200mm); 1 Zone (Ø 280mm); 1 Zone (Ø 185mm)
Maximum nominal power 7200 W, SlideCooking, Touch Control,
Power limiter, Child safety lock, Ceramic glass surface.

DIMENSIONI DIMENSIONS
800 x 510 mm

FORO INCASSO BUILT-IN
750 x 490 mm

ALTEZZA TOP_HOB HEIGHT
4 mm

INGOMBRO SOTTOPIANO_UNDERMOUNT CLEARANCE
49 mm

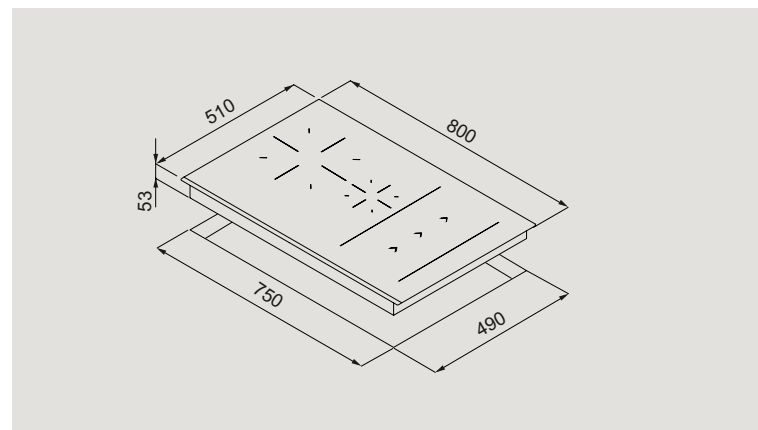

COOKING HOBS

PIANI COTTURA

Gas PLANO PLUS 75

FLAT BURNERS

Design del prodotto raffinato, perfezionato per la minima dispersione di calore. Le forme essenziali dei bruciatori racchiudono tecnica e ricerca in un unico prodotto, per il perfetto connubio: minimo utilizzo di gas, massima resa funzionale.

Refined product design, perfected to ensure minimal heat loss. The essential shapes of the burners combine technology and research in a single product, creating the perfect combination: minimum use of gas, maximum functional efficiency.

DESIGN TOTAL BLACK

Personalità seducente e linee estetiche di pregio si tingono di nero. Bruciatori e griglie Total Black per uno styling contemporaneo dell'ambiente cucina.

Seductive personality and fine aesthetic lines are tinged with black. Total Black burners and pan supports for contemporary styling of the kitchen environment.

STEP FLAME

Controlli ottimizzati con nove livelli di potenza per una precisione totale. Manopole ergonomiche assicurano una gestualità fluida per il minimo spreco energetico. Il potere è tutto tra le mani.

Optimised controls with nine power levels providing total precision. Ergonomic knobs ensure smooth handling for minimal energy wastage. The power is all in your hands.

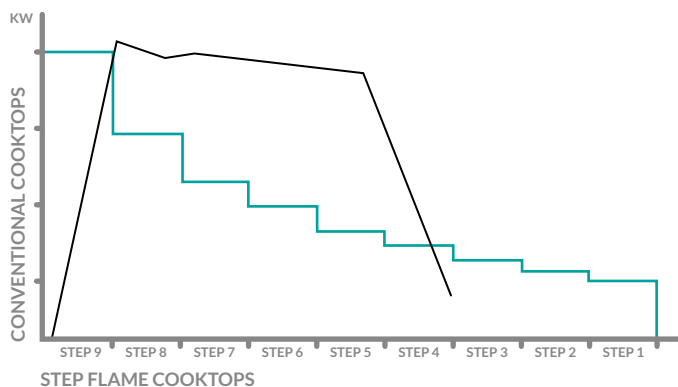

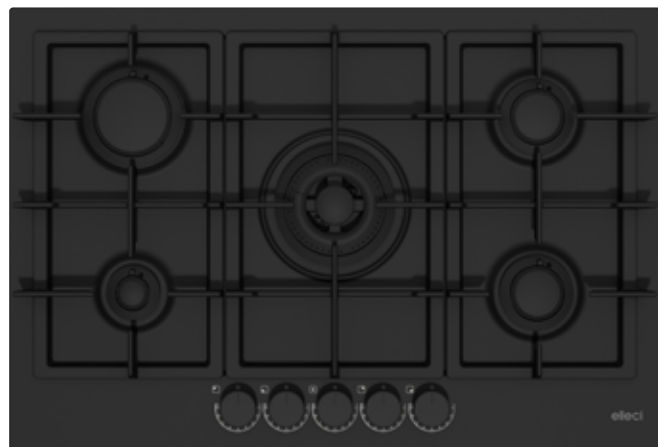

PGPP751BKCS

Piano a gas da incasso smaltato
Enamelled built-in gas hob



5 fuochi flat a gas, di cui una tripla corona centrale, 1 Tripla Corona 4 kW; 1 Rapido 3 kW; 2 Semirapido 1,75 kW; 1 Ausiliario 1 kW, Flame Step Control, Accensione integrata nella manopola, Valvola di sicurezza, Griglie e coprispartifiamma in ghisa, estetica in acciaio nero opaco con superficie smaltata sempre nero opaco, Manopole Flat Nero.

5 flat gas burners, including 1 central triple-crown burner, 1 triple crown 4 kW; 1 rapid 3 kW; 2 semi-rapid 1,75 Kw; 1 auxiliary 1 kW, Flame Step Control, Automatic under-knob ignition, Safety valve, Cast iron pan supports and flame cap cover grids and burner covers in aesthetic cast iron in matt black steel with matt black enamelled surface, Flat Black knobs.

DIMENSIONI DIMENSIONS
750 x 510 mm

FORO INCASSO_BUILT-IN
553 x 473 mm

ALTEZZA TOP_HOB HEIGHT
8 mm

INGOMBRO SOTTOPIANO_UNDERMOUNT CLEARANCE
45 mm

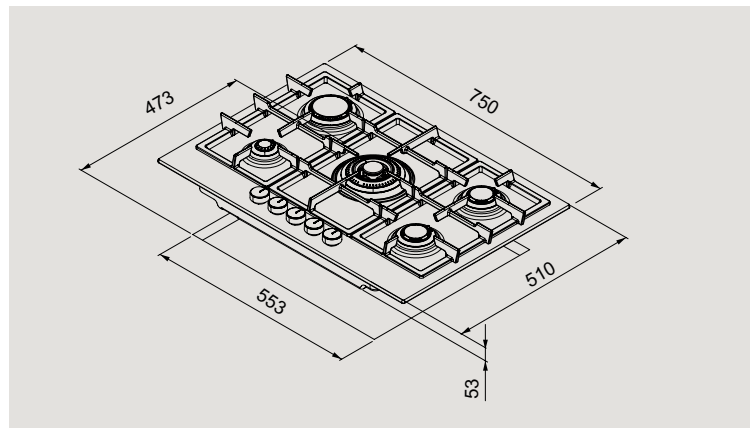

GREEN POWER

BLACK EDITION

1000 TOP

DISSIPATORE ORGANIC WASTE DISPOSER

Nella dotazione di serie
è incluso il Remote Control

Remote Control is included



DIMENSIONI | DIMENSIONS
205 x 420 mm

POTENZA HP | WATT_POWER IN HP | WATTS
1/750

TENSIONE VAC_VOLTAGE IN VAC
220/240

ASSORBIMENTO_INPUT (AMPERE)
3,4

R/MIN
2800

PESO (KG) VAC_WEIGHT (KG) VAC
4,8

CAPACITÀ_CAPACITY
1070ml

TDH01000BK

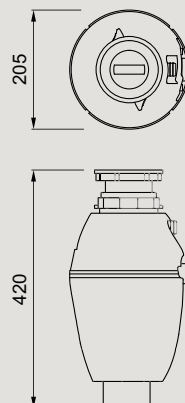

CARE AND MAINTENANCE

elleci | LAB

CURA E MANUTENZIONE



elleci | BEAUTY

UN SET DI PRODOTTI CON SPECIFICHE CARATTERISTICHE, REALIZZATI PER FACILITARE LA PULIZIA E MANTENERE NEL TEMPO LA BELLEZZA DEI PRODOTTI ELLECI.

A SERIES OF PRODUCTS WITH SPECIFIC FEATURES, DESIGNED TO FACILITATE CLEANING AND MAINTAIN THE BEAUTY OF ELLECI PRODUCTS OVER TIME.

DISCOVER



elleci | BEAUTY

Mantenere nel tempo l'estetica e la funzionalità del prodotto è estremamente semplice. E' sufficiente pulire ed asciugare quotidianamente utilizzando detergenti neutri o specifici della linea Elleci Beauty senza lasciare che depositi e residui agiscano a lungo sulle superfici.

Maintaining the aesthetics and functionality of the bowl over time is extremely simple. Just clean the bowl daily with water, dish detergent or Elleci Beauty specific product and a soft cloth, without letting deposits and residues act for a long time on the surfaces.



Rimuovere eventuali macchie utilizzando una spugna morbida e un detergente neutro per i piatti o un prodotto specifico della linea Elleci Beauty.

Remove any stains using a soft cloth or sponge with normal dish detergent or a specific Elleci Beauty product.



Asciugare con cura la superficie con un panno morbido o in microfibra per impedire la formazione di depositi di calcare.

Dry the wet areas thoroughly with a microfibre cloth to prevent the formation of limescale deposits.



Risciacquare abbondantemente le superfici utilizzando acqua tiepida.

Rinse the surfaces thoroughly with warm water.



Per prevenire la formazione delle macchie di calcare sulla superficie, si raccomanda di eseguire una pulizia più approfondita una o due volte alla settimana utilizzando un detergente anticalcare disincrostante come lo spray anticalcare Daily Clean della linea Elleci Beauty.

To prevent the formation of limestone stains on the bowl, it is also recommended to decalcify the bowl once or twice a week, using a descaling detergent or a specific Elleci Beauty product as Daily Clean anti-limescale spray.

ULTERIORI AVVERTENZE E CONSIGLI
ADDITIONAL WARNINGS AND ADVICES



produced by
Elleci S.p.A.
project coordination

in cooperation with
Archè Agency S.r.l.

Elleci S.p.A.
Strada Longitudinale A 1258
Zona industriale Mazzocchio
04014 Pontinia (LT) - Italy
Tel. +39 0773.84.00.36
Fax +39 0773.85.35.17
elleci@elleci.it
www.elleci.com

Precious. Lifestyle is here.